



Lucky Light

Subminiature Axial Warm White Chip LED
Technical Data Sheet

Part No.: AR180W-W6-1E-TR2



Features:

- 2.10×2.40mm with 1.80mm lens.
- EIA Std. package.
- Mono-color type.
- The product itself will remain within RoHS compliant version.

Descriptions:

- The AR180 SMD taping is much smaller than leaded components. Thus enable smaller board size. Higher packing density. Reduced storage space and finally smaller equipment to be obtained.
- Besides, light weight makes them ideal for miniature applications.
- Furthermore by automation assembly machines the accuracy is anticipated.

Applications:

- Small indicator for indoor applications.
- Flat backlight for LCD, switches and symbols.
- Indicator and backlight in office equipment.
- Indicator and backlight for battery driven equipment.
- Indicator and backlight for audio and video equipment.
- Automotive: Backlighting in dashboards and switches.
- Telecommunication: Indicator and backlighting in telephone and fax.

Package Dimension:

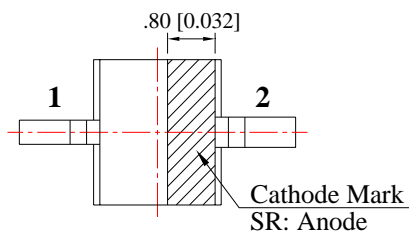
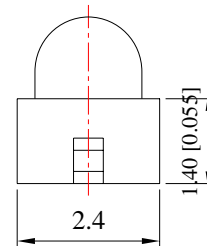
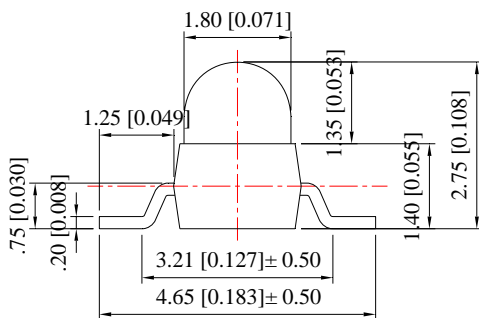
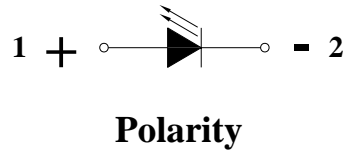
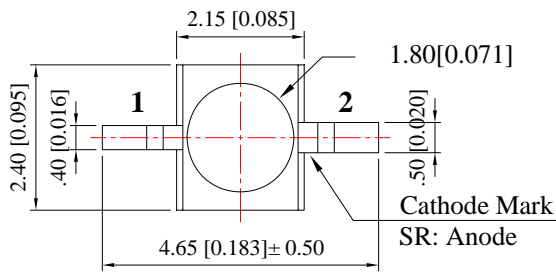

Recommended Soldering Pad Dimensions

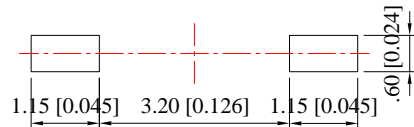

Unit: mm
Tolerance: ± 0.10 mm

Part No.	Chip Material	Lens Color	Source Color
AR180W-W6-1E-TR2	InGaN	Yellow Diffused	Warm White

Notes:

1. All dimensions are in millimeters (inches).
2. Tolerance is ± 0.10 mm (.004") unless otherwise specified.
3. Specifications are subject to change without notice.

Absolute Maximum Ratings at Ta=25

Parameters	Symbol	Max.	Unit
Power Dissipation	PD	95	mW
Peak Forward Current (1/10 Duty Cycle, 0.1ms Pulse Width)	IFP	100	mA
Continuous Forward Current	IF	25	mA
Reverse Voltage	VR	5	V
Electrostatic Discharge (HBM)	ESD	400	V
Operating Temperature Range	Topr	-40 to +80	
Storage Temperature Range	Tstg	-40 to +85	
Soldering Temperature	Tsld	260 for 5 Seconds	

Electrical Optical Characteristics at Ta=25

Parameters	Symbol	Min.	Typ.	Max.	Unit	Test Condition
Luminous Intensity (Note 1) *	IV	1500	3000	---	mcd	IF=20mA (Note 1)
Viewing Angle (Note 2) *	2θ _{1/2}	---	60	---	Deg	IF=20mA (Note 2)
Chromaticity Coordinates (Note 3)	X	---	0.43	---		IF=20mA (Note 3)
	Y	---	0.40	---		
Color Temperature	CCT	2600	3000	3800	K	IF=20mA
Forward Voltage	VF	2.80	3.40	3.80	V	IF=20mA
Reverse Current	IR	---	---	10	μA	VR=5V

Notes:

- Luminous Intensity (Flux) Measurement allowance is $\pm 10\%$.
- $\theta_{1/2}$ is the off-axis angle at which the luminous intensity is half the axial luminous intensity.
- It use many parameters that correspond to the CIE 1931 2°. X, Y, and Z are CIE 1931 2° values of Red, Green and Blue content of the measurement.

Typical Electrical / Optical Characteristics Curves
 (25 Ambient Temperature Unless Otherwise Noted)

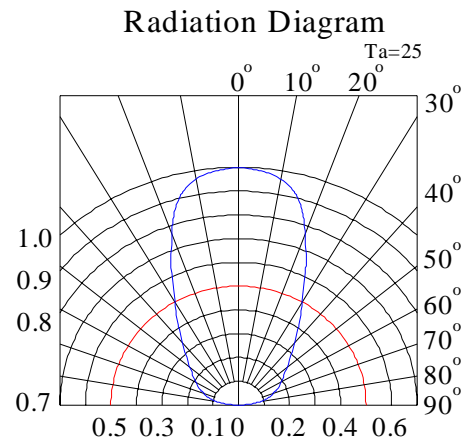
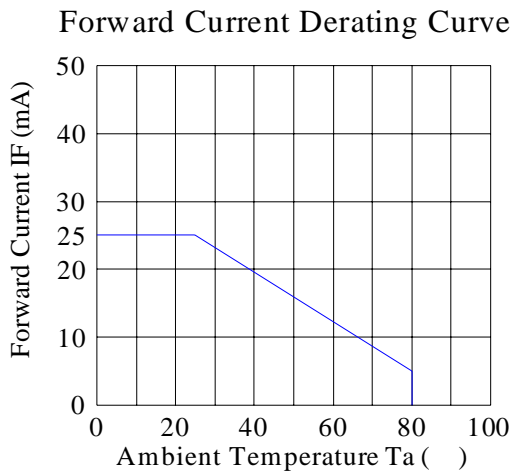
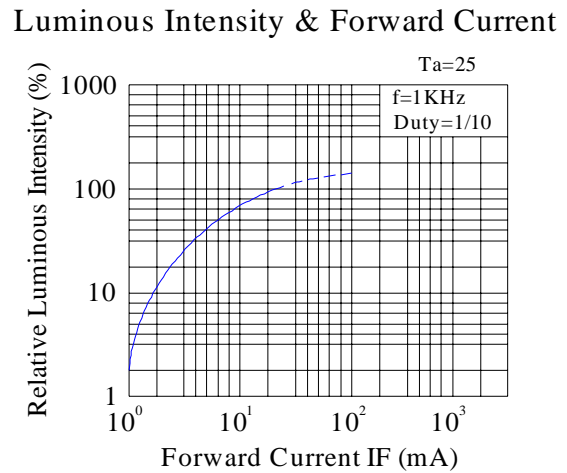
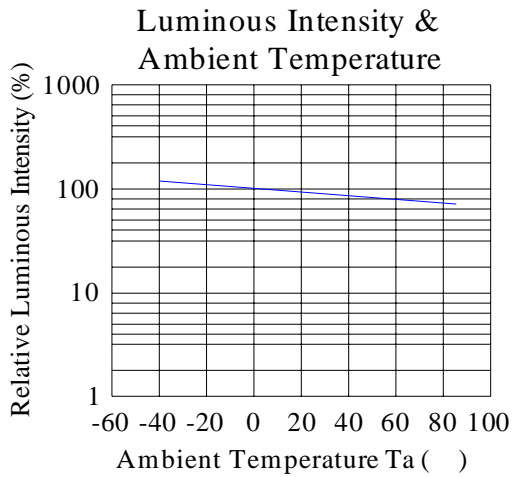
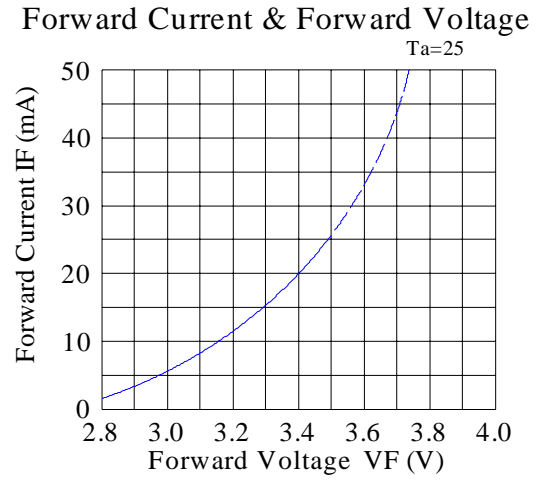
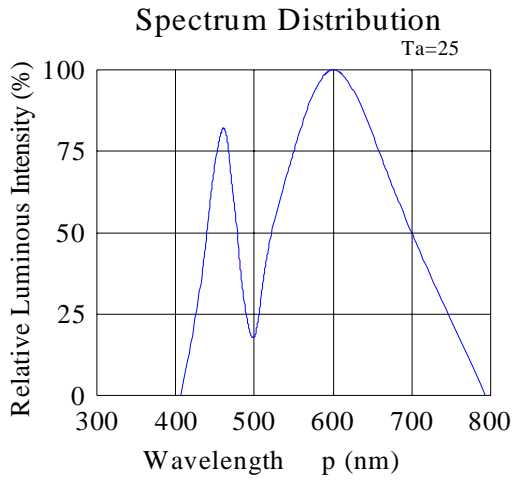

Warm White CIE 1931 Chromaticity Diagram:

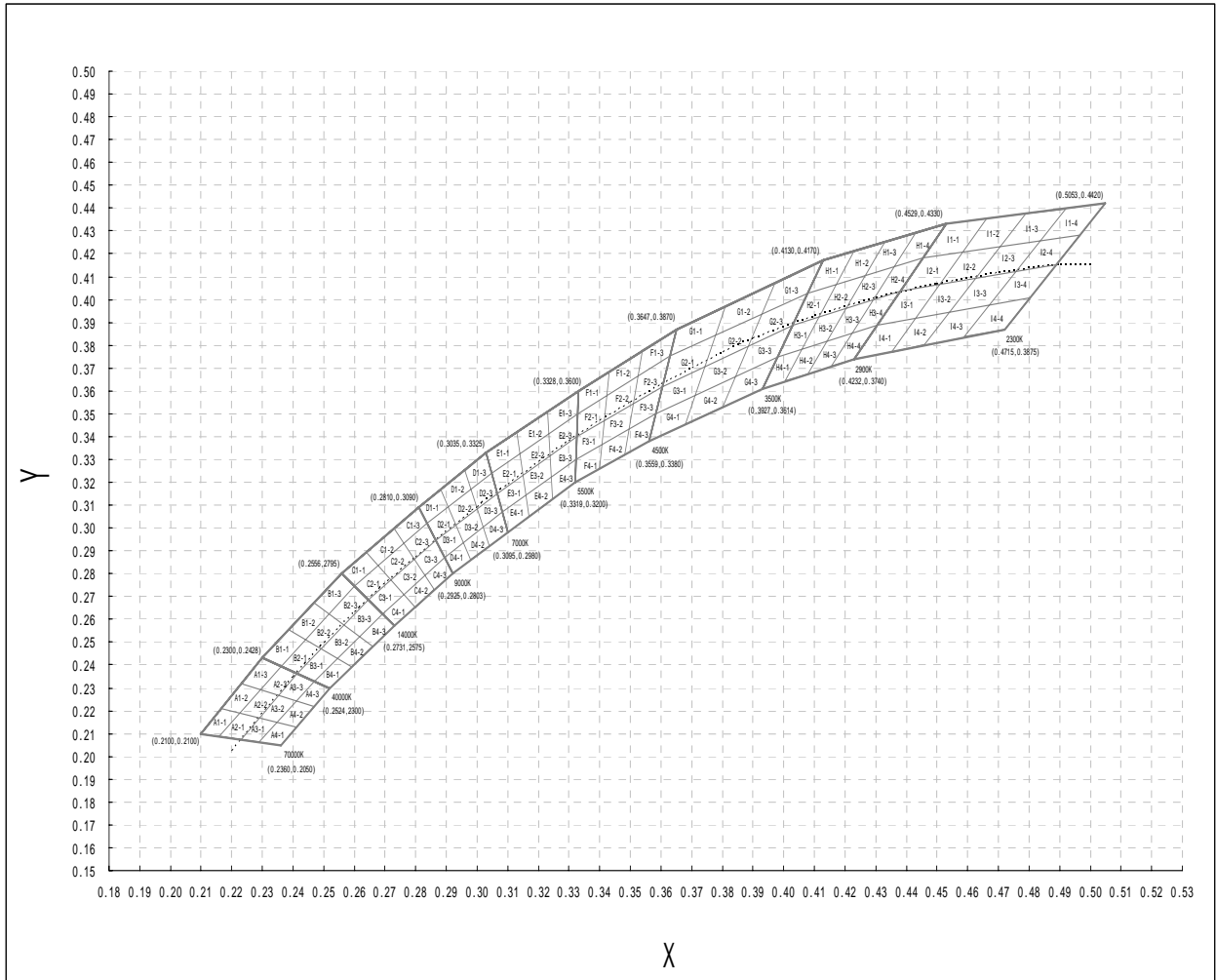

W6

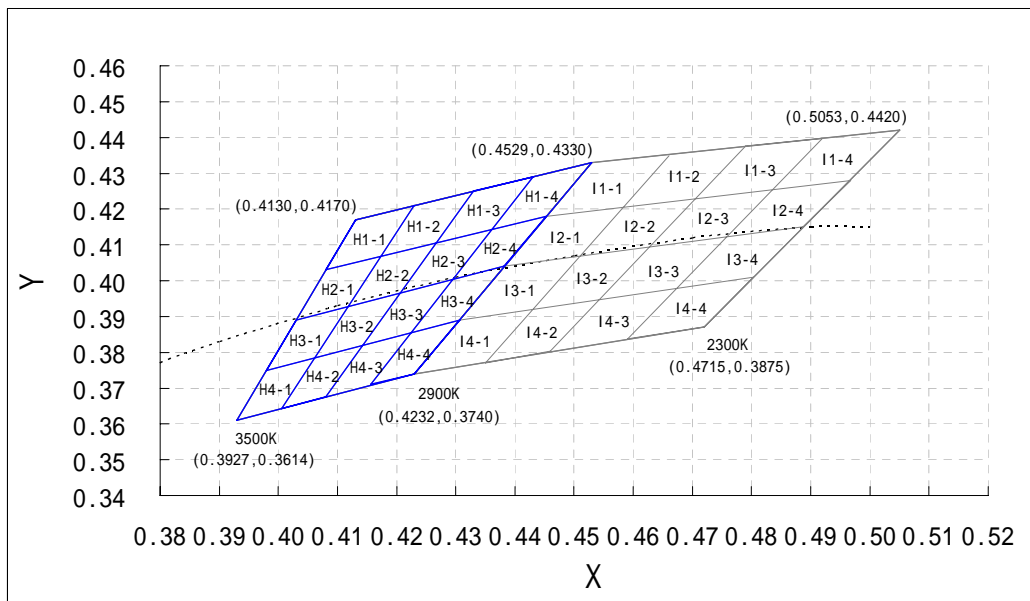

Chromaticity Coordinates Specifications for Bin Rank:

Bin Code	Left x	Left y	Top x	Top y	Right x	Right y	Bottom x	Bottom y
H1-1	0.4130	0.4170	0.4230	0.4210	0.4170	0.4070	0.4080	0.4030
H2-1	0.4080	0.4030	0.4170	0.4070	0.4120	0.3930	0.4030	0.3890
H3-1	0.4030	0.3890	0.4120	0.3930	0.4060	0.3790	0.3980	0.3750
H4-1	0.3980	0.3750	0.4060	0.3790	0.4000	0.3650	0.3930	0.3610
H1-2	0.4230	0.4210	0.4330	0.4250	0.4270	0.4110	0.4170	0.4070
H2-2	0.4170	0.4070	0.4270	0.4110	0.4200	0.3960	0.4120	0.3930
H3-2	0.4120	0.39300	0.4200	0.3960	0.4140	0.3820	0.4060	0.3790
H4-2	0.4060	0.3790	0.4140	0.3820	0.4080	0.3680	0.4000	0.3650
H1-3	0.4330	0.4250	0.4430	0.4290	0.4360	0.4140	0.4270	0.4110
H2-3	0.4270	0.4110	0.4360	0.4140	0.4290	0.4000	0.4200	0.3960
H3-3	0.4200	0.3960	0.4290	0.4000	0.4220	0.3850	0.4140	0.3820
H4-3	0.4140	0.3820	0.4220	0.3850	0.4160	0.3710	0.4080	0.3680
H1-4	0.4430	0.4290	0.4530	0.4330	0.4450	0.4180	0.4360	0.4140
H2-4	0.4360	0.4140	0.4450	0.4180	0.4380	0.4040	0.4290	0.4000
H3-4	0.4290	0.4000	0.4380	0.4040	0.4310	0.3890	0.4220	0.3850
H4-4	0.4220	0.3850	0.4310	0.3890	0.4230	0.3740	0.4160	0.3710
I1-1	0.4530	0.4330	0.4660	0.4350	0.4580	0.4210	0.4450	0.4180
I2-1	0.4450	0.4180	0.4580	0.4210	0.4510	0.4060	0.4380	0.4040
I3-1	0.4380	0.4040	0.4510	0.4060	0.4430	0.3920	0.4310	0.3890
I4-1	0.4310	0.3890	0.4430	0.3920	0.4350	0.3770	0.4230	0.3740
I1-2	0.4660	0.4350	0.4790	0.4380	0.4710	0.4230	0.4580	0.4210
I2-2	0.4580	0.4210	0.4710	0.4230	0.4630	0.4090	0.4510	0.4060
I3-2	0.4510	0.4060	0.4630	0.4090	0.4550	0.3950	0.4430	0.3920
I4-2	0.4430	0.3920	0.4550	0.3950	0.4470	0.3810	0.4350	0.3770
I1-3	0.4790	0.4380	0.4920	0.4400	0.4840	0.4260	0.4710	0.4230
I2-3	0.4710	0.4230	0.4840	0.4260	0.4760	0.4120	0.4630	0.4090
I3-3	0.4630	0.4090	0.4760	0.4120	0.4680	0.3980	0.4550	0.3950
I4-3	0.4550	0.3950	0.4680	0.3980	0.4590	0.3840	0.4470	0.3810
I1-4	0.4920	0.4400	0.5050	0.4420	0.4970	0.4280	0.4840	0.4260
I2-4	0.4840	0.4260	0.4970	0.4280	0.4880	0.4150	0.4760	0.4120
I3-4	0.4760	0.4120	0.4880	0.4150	0.4800	0.4010	0.4680	0.3980
I4-4	0.4680	0.3980	0.4800	0.4010	0.4720	0.3870	0.4590	0.3840

Notes:

1. Color coordinates measurement allowance is ± 0.01 .
2. One delivery will include up to two consecutive color ranks and three luminous intensity ranks of the products the quantity-ratio of the ranks is decided by **Lucky Light**.

Reliability Test Items And Conditions:

The reliability of products shall be satisfied with items listed below:

Confidence level: 90%.

LTPD: 10%.

1) Test Items and Results:

No.	Test Item	Test Hours/Cycles	Test Conditions	Sample Size	Ac/Re
1	Resistance to Soldering Heat	6 Min.	Tsld=260±5 , Min. 5sec	25pcs	0/1
2	Thermal Shock	300 Cycles	H: +100 5min ∫ 10 sec L: -10 5min	25pcs	0/1
3	Temperature Cycle	300 Cycles	H: +100 15min ∫ 5min L: -40 15min	25pcs	0/1
4	High Temperature Storage	1000Hrs.	Temp: 100	25pcs	0/1
5	DC Operating Life	1000Hrs.	IF=20mA	25pcs	0/1
6	Low Temperature Storage	1000Hrs.	Temp: -40	25pcs	0/1
7	High Temperature/ High Humidity	1000Hrs.	85 /85%RH	25pcs	0/1

2) Criteria for Judging the Damage:

Item	Symbol	Test Conditions	Criteria for Judgment	
			Min	Max
Forward Voltage	VF	IF=20mA	---	F.V.*)×1.1
Reverse Current	IR	VR=5V	---	F.V.*)×2.0
Luminous Intensity	IV	IF=20mA	F.V.*)×0.7	---

*) F.V.: First Value.

Please read the following notes before using the product:

1. Over-current-proof

Customer must apply resistors for protection, otherwise slight voltage shift will cause big current change (Burn out will happen).

2. Storage

2.1 Do not open moisture proof bag before the products are ready to use.

2.2 Before opening the package, the LEDs should be kept at 30 °C or less and 80%RH or less.

2.3 The LEDs should be used within a year.

2.4 After opening the package, the LEDs should be kept at 30 °C or less and 60%RH or less.

2.5 The LEDs should be used within 168 hours (7 days) after opening the package.

2.6 If the moisture adsorbent material has fabled away or the LEDs have exceeded the storage time, baking treatment should be performed using the following conditions. Baking treatment: 60±5 °C for 24 hours.

3. Soldering Condition

When soldering, for Lamp without stopper type and must be leave a minimum of 3mm clearance from the base of the lens to the soldering point.

To avoided the Epoxy climb up on lead frame and was impact to non-soldering problem, dipping the lens into the solder must be avoided.

Do not apply any external stress to the lead frame during soldering while the LED is at high temperature.

Recommended soldering conditions:

Soldering Iron		Wave Soldering	
Temperature	300 °C Max.	Pre-heat	100 °C Max.
Soldering Time	3 sec. Max. (one time only)	Pre-heat Time	60 sec. Max.
		Solder Wave	260 °C Max.
		Soldering Time	5 sec. Max.

Note: Excessive soldering temperature and / or time might result in deformation of the LED lens or catastrophic failure of the LED.

4. Soldering Iron

Each terminal is to go to the tip of soldering iron temperature less than 260 °C for 5 seconds within once in less than the soldering iron capacity 25W. Leave two seconds and more intervals, and do soldering of each terminal. Be careful because the damage of the product is often started at the time of the hand solder.

5. Repairing

Repair should not be done after the LEDs have been soldered. When repairing is unavoidable, a double-head soldering iron should be used (as below figure). It should be confirmed beforehand whether the characteristics of the LEDs will or will not be damaged by repairing.

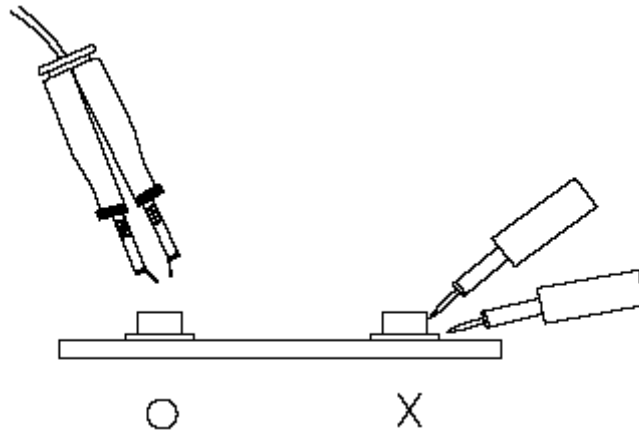

6. Caution in ESD

Static Electricity and surge damages the LED. It is recommended to use a wrist band or anti-electrostatic glove when handling the LED. All devices, equipment and machinery must be properly grounded.