

0.60mm Height PLCC-2 Package Side View
Super Amber Chip LED
Technical Data Sheet

Part No.: V020UAC-2A-RL

Features:

- Side view type.
- White SMT package.
- PLCC-2 SMT package.
- Lead frame package with individual 2 pins.
- Mono-color type.
- Wide viewing angle.
- Soldering methods: IR reflow soldering.
- Feature of the device: More light due to higher optical efficiency; extremely wide viewing angle. Ideal for backlighting and coupling in light guide.
- Compatible with automatic placement equipment.
- Compatible with infrared and vapor phase reflow solder process.
- The product itself will remain within RoHS compliant Version.

Descriptions:

Due to the package design, the V020 SMD LED has wide viewing angle, low power consumption. This feature makes the LED ideal for light guide application.

The V020 SMD LEDs much smaller than lead frame type components, thus enable smaller board size, higher packing density, reduced storage space and finally smaller equipment to be obtained.

Utilizing advanced AlGaInP chip technology.

Besides, lightweight makes them ideal for miniature applications, etc.

Applications:

- Automotive: Backlighting in dashboard and switch.
- Telecommunication: Indicator and backlighting in telephone and fax.
- Flat backlight for LCD, switch and symbol.
- Indoor signboard use.
- LCD Back Light.
- Indicators.
- Illuminations.
- Mobile phones.
- General use.

Package Dimension:

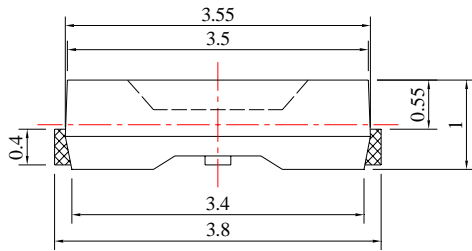

Top View

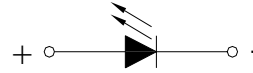

Polarity

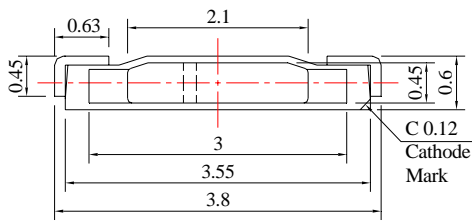

Side View

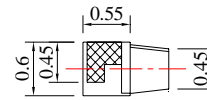

Side View

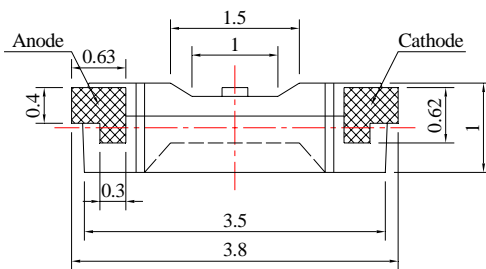

Bottom View

Recommended Soldering Pad Dimensions

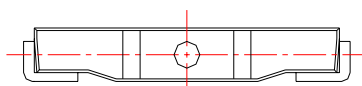
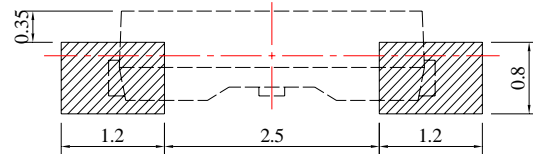

The Other Side View

Unit: mm
Tolerance: $\pm 0.10\text{mm}$

Part No.	Chip Material	Lens Color	Source Color
V020UAC-2A-RL	AlGaInP	Water Clear	Super Amber

Notes:

1. All dimensions are in millimeters (inches).
2. Tolerance is $\pm 0.10\text{mm}$ (.004") unless otherwise specified.
3. Specifications are subject to change without notice.

Absolute Maximum Ratings at Ta=25

Parameters	Symbol	Max.	Unit
Power Dissipation	PD	60	mW
Peak Forward Current (1/10 Duty Cycle, 0.1ms Pulse Width)	IFP	100	mA
Forward Current	IF	25	mA
Reverse Voltage	VR	5	V
Electrostatic Discharge (HBM)	ESD	2000	V
Operating Temperature Range	Topr	-40 to +80	
Storage Temperature Range	Tstg	-40 to +85	
Soldering Temperature	Tsld	Reflow Soldering: 260 for 5 Seconds Hand Soldering: 350 for 3 Seconds	

Electrical Optical Characteristics at Ta=25

Parameters	Symbol	Min.	Typ.	Max.	Unit	Test Condition
Luminous Intensity *	IV	200	350	---	mcd	IF=20mA (Note 1)
Viewing Angle *	2θ _{1/2}	---	120	---	Deg	IF=20mA (Note 2)
Peak Emission Wavelength	λ _p	---	610	---	nm	IF=20mA
Dominant Wavelength	λ _d	---	605	---	nm	IF=20mA (Note 3)
Spectral Line Half-Width	λ	---	35	---	nm	IF=20mA
Forward Voltage	VF	1.60	2.00	2.40	V	IF=20mA
Reverse Current	IR	---	---	10	μA	V _R =5V

Notes:

- Luminous Intensity Measurement allowance is ± 10%.
- θ_{1/2} is the off-axis angle at which the luminous intensity is half the axial luminous intensity.
- The dominant wavelength (λ_d) is derived from the CIE chromaticity diagram and represents the single wavelength which defines the color of the device.

Typical Electrical / Optical Characteristics Curves
(25 Ambient Temperature Unless Otherwise Noted)

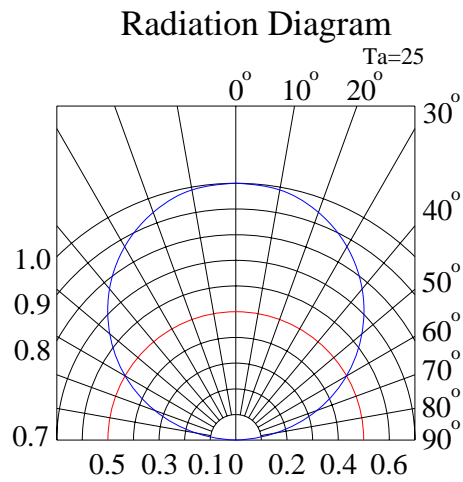
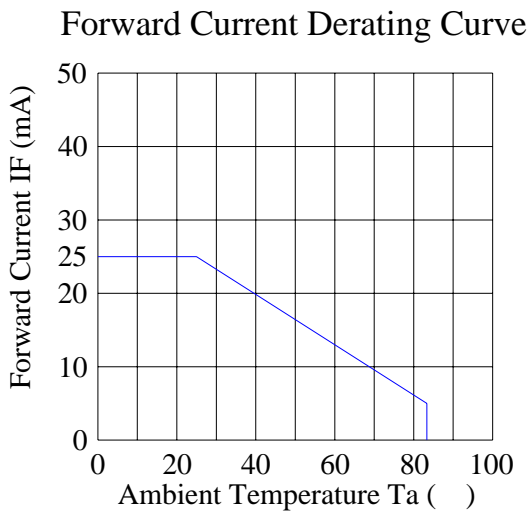
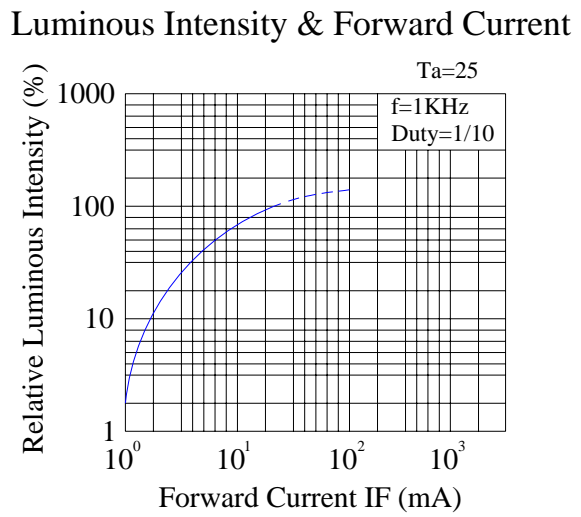
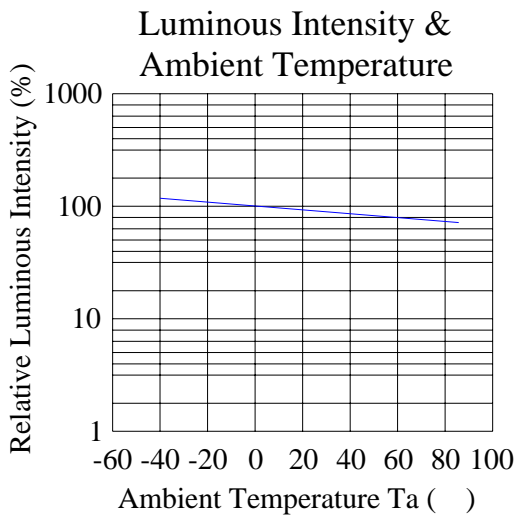
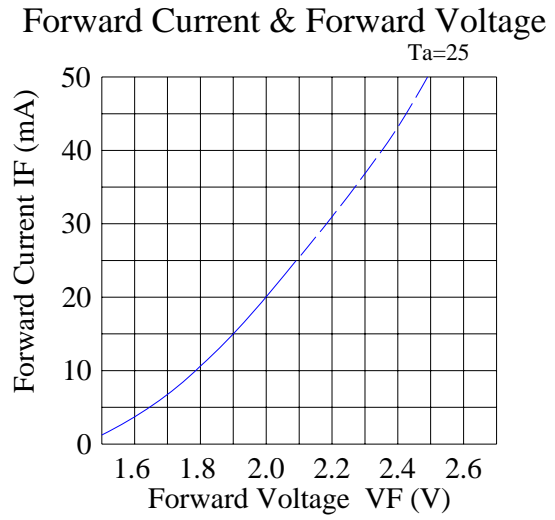
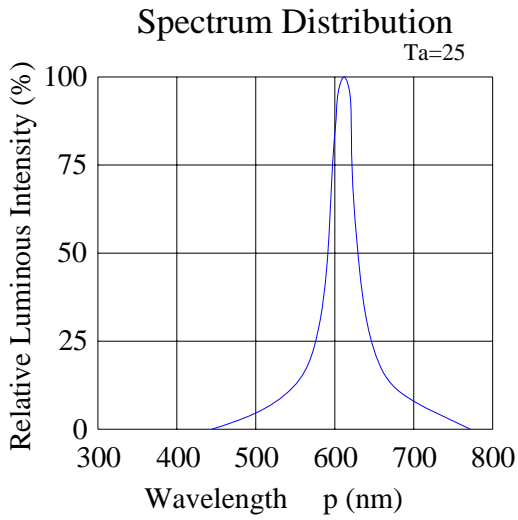

Reliability Test Items And Conditions:

The reliability of products shall be satisfied with items listed below:

Confidence level: 90%.

LTPD: 10%.

1) Test Items and Results:

No.	Test Item	Test Hours/Cycles	Test Conditions	Sample Size	Ac/Re
1	Resistance to Soldering Heat	6 Min	Tsld=260±5 , Min. 5sec	25pcs	0/1
2	Thermal Shock	300 Cycles	H: +100 5min f 10 sec L: -10 5min	25pcs	0/1
3	Temperature Cycle	300 Cycles	H: +100 15min f 5min L: -40 15min	25pcs	0/1
4	High Temperature Storage	1000Hrs.	Temp: 100	25pcs	0/1
5	DC Operating Life	1000Hrs.	IF=20mA	25pcs	0/1
6	Low Temperature Storage	1000Hrs.	Temp: -40	25pcs	0/1
7	High Temperature/ High Humidity	1000Hrs.	85 /85%RH	25pcs	0/1

2) Criteria for Judging the Damage:

Item	Symbol	Test Conditions	Criteria for Judgment	
			Min	Max
Forward Voltage	VF	IF=20mA	---	F.V.*)×1.1
Reverse Current	IR	VR=5V	---	F.V.*)×2.0
Luminous Intensity	IV	IF=20mA	F.V.*)×0.7	---

*) F.V.: First Value.

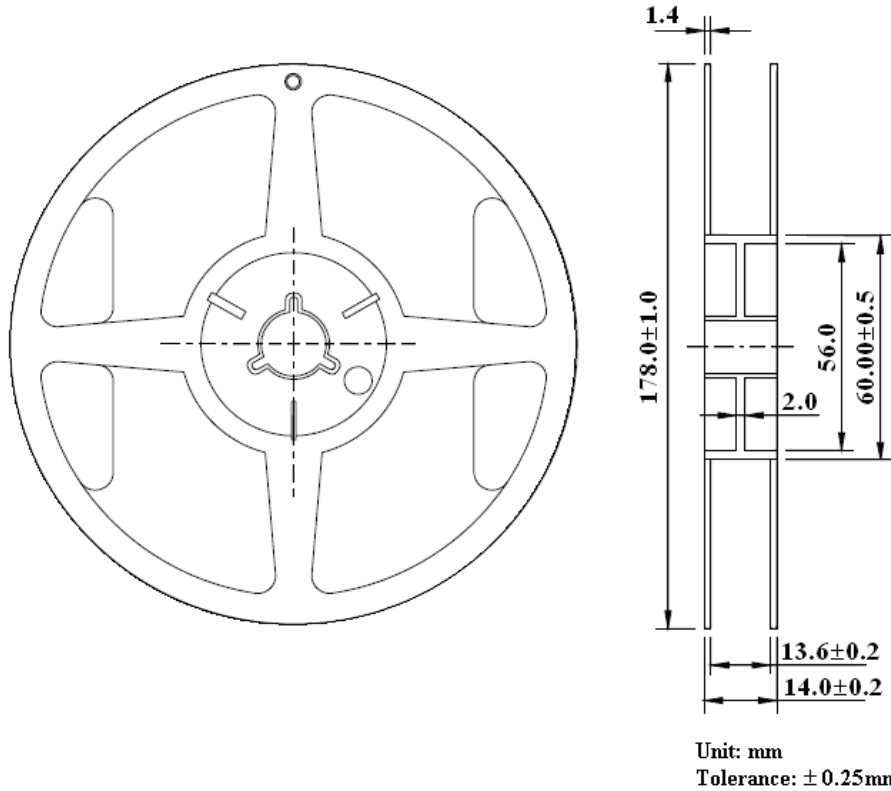
Reel Dimensions:

Carrier Tape Dimensions:

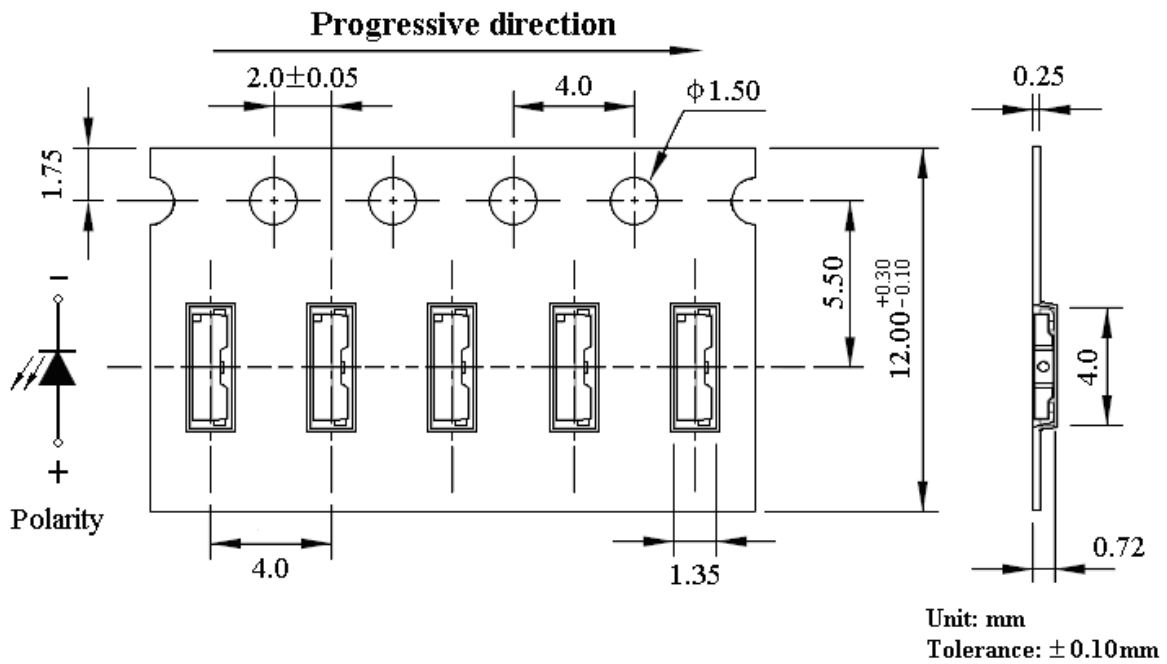
Loaded quantity 3000PCS per reel.



Please read the following notes before using the product:

1. Over-current-proof

Customer must apply resistors for protection, otherwise slight voltage shift will cause big current change (Burn out will happen).

2. Storage

2.1 Do not open moisture proof bag before the products are ready to use.

2.2 Before opening the package, the LEDs should be kept at 30 °C or less and 80%RH or less.

2.3 The LEDs should be used within a year.

2.4 After opening the package, the LEDs should be kept at 30 °C or less and 60%RH or less.

2.5 The LEDs should be used within 168 hours (7 days) after opening the package.

2.6 If the moisture adsorbent material has fabled away or the LEDs have exceeded the storage time, baking treatment should be performed using the following conditions. Baking treatment: 60±5 °C for 24 hours.

3. Soldering Condition

When soldering, for Lamp without stopper type and must be leave a minimum of 3mm clearance from the base of the lens to the soldering point.

To avoided the Epoxy climb up on lead frame and was impact to non-soldering problem, dipping the lens into the solder must be avoided.

Do not apply any external stress to the lead frame during soldering while the LED is at high temperature.

Recommended soldering conditions:

Soldering Iron		Wave Soldering	
Temperature	300 °C Max.	Pre-heat	100 °C Max.
Soldering Time	3 sec. Max. (one time only)	Pre-heat Time	60 sec. Max.
		Solder Wave	260 °C Max.
		Soldering Time	5 sec. Max.

Note: Excessive soldering temperature and / or time might result in deformation of the LED lens or catastrophic failure of the LED.

4. Soldering Iron

Each terminal is to go to the tip of soldering iron temperature less than 260 °C for 5 seconds within once in less than the soldering iron capacity 25W. Leave two seconds and more intervals, and do soldering of each terminal. Be careful because the damage of the product is often started at the time of the hand solder.

5. Repairing

Repair should not be done after the LEDs have been soldered. When repairing is unavoidable, a double-head soldering iron should be used (as below figure). It should be confirmed beforehand whether the characteristics of the LEDs will or will not be damaged by repairing.



6. Caution in ESD

Static Electricity and surge damages the LED. It is recommended to use a wrist band or anti-electrostatic glove when handling the LED. All devices, equipment and machinery must be properly grounded.