

0.51" Dual Digit Ultra Yellow Green
SMD Displays
Technical Data Sheet

Model No.: KW2-S511XUGA



Features:

- 0.51" (inch) digit height.
- Packaged in tape and reel for SMT manufacturing.
- Design flexibility (common cathode and anode).
- Categorized for luminous intensity.
- The thickness is thinner than traditional display.
- The product itself will remain within RoHS compliant Version.

Descriptions:

- The SMD type is much smaller than traditional type components, thus enabling smaller board size, higher packing density, reduced storage space and finally smaller equipment to be obtained.
- These devices are made with white segments and gray surface.

Applications:

- Suitable for indoor use.
- Audio equipment.
- Set top box.
- Game machine.
- Channel indicator of TV.

Device Selection Guide:

Model No.	Chip Material	Source Color	Description
KW2-S511CUGA	AlGaInP	Ultra Yellow Green	Common Cathode
KW2-S511AUGA		Ultra Yellow Green	Common Anode

Package Dimension:

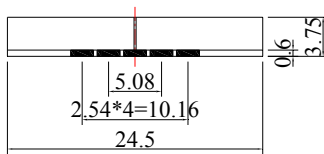
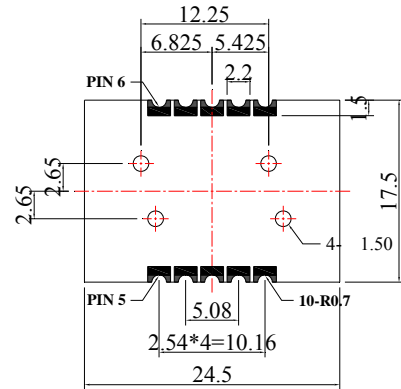
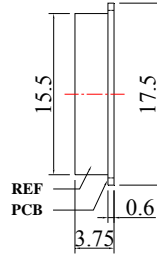
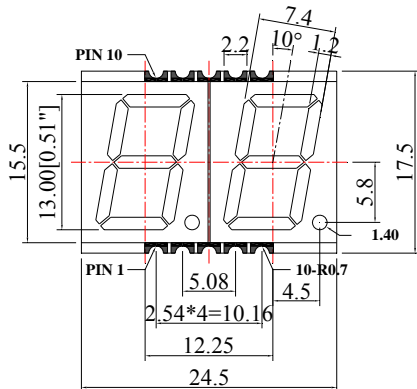

DIG. 1 DIG. 2

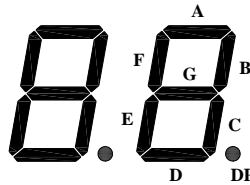

Recommended Soldering Pad Dimensions

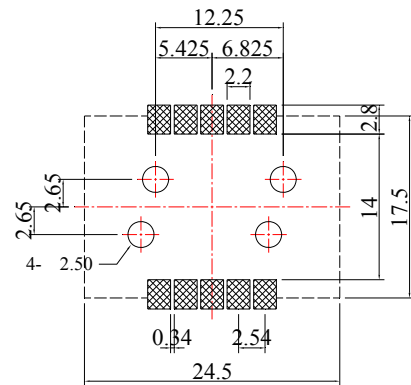

Unit: mm
Tolerance: ±0.25 mm

KW2-S511CUGA

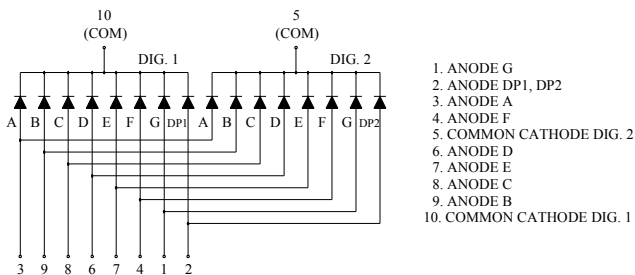

KW2-S511AUGA

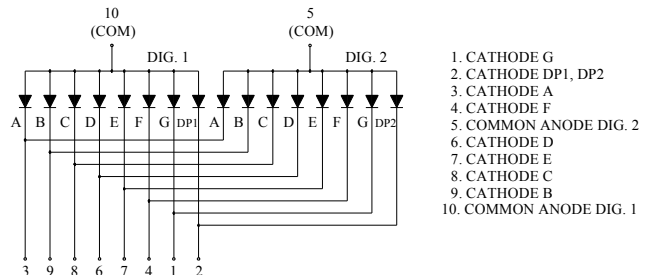

Notes:

1. All dimensions are in millimeters (inches).
2. Tolerance is ± 0.25mm (.010") unless otherwise noted.
3. Specifications are subject to change without notice.

Absolute Maximum Ratings at Ta=25

Parameters	Symbol	Max.	Unit
Power Dissipation (Per Segment)	PD	65	mW
Peak Forward Current (Per Segment) (1/10 Duty Cycle, 0.1ms Pulse Width)	IFP	100	mA
Continuous Forward Current (Per Segment)	IF	25	mA
Derating Linear From 50		0.4	mA/
Reverse Voltage	VR	5	V
Operating Temperature Range	Topr	-40 to +80	
Storage Temperature Range	Tstg	-40 to +85	
Soldering Temperature	Tsld	260 for 5 Seconds	

Electrical Optical Characteristics at Ta=25

Parameters	Symbol	Min.	Typ.	Max.	Unit	Test Condition
Luminous Intensity (Per Segment)	IV	3.00	6.00	---	mcd	IF=10mA (Note 1)
Luminous Intensity Matching Ratio (Segment To Segment)	IV-M	---	---	2:1		IF=10mA
Peak Emission Wavelength	λ_p	---	575	---	nm	IF=20mA
Dominant Wavelength	λ_d	---	573	---	nm	IF=20mA (Note 2)
Spectral Line Half-Width	λ	---	20	---	nm	IF=20mA
Forward Voltage (Per Segment)	VF	1.60	2.20	2.60	V	IF=20mA
Reverse Current (Per Segment)	IR	---	---	100	μ A	VR=5V

Notes:

- Luminous intensity is measured with a light sensor and filter combination that approximates the CIE eye-response curve.
- The dominant wavelength (λ_d) is derived from the CIE chromaticity diagram and represents the single wavelength which defines the color of the device.

Typical Electrical / Optical Characteristics Curves
 (25 Ambient Temperature Unless Otherwise Noted)

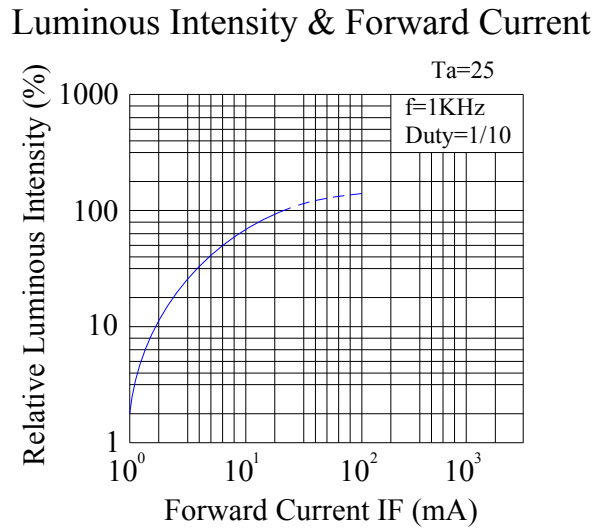
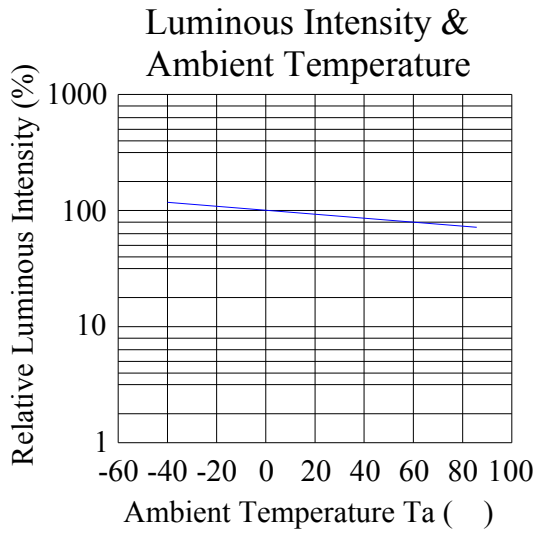
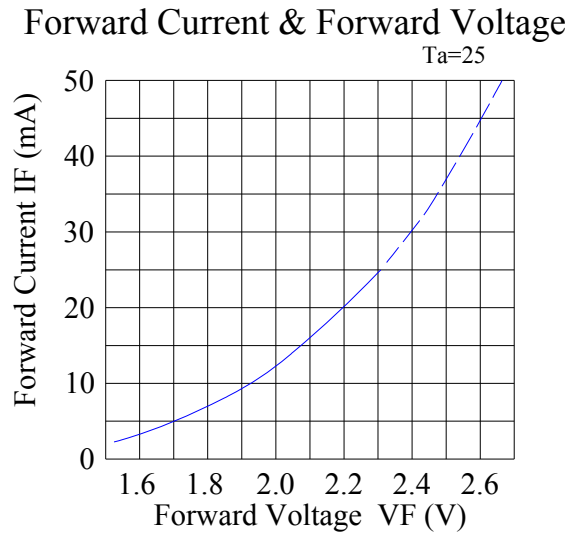
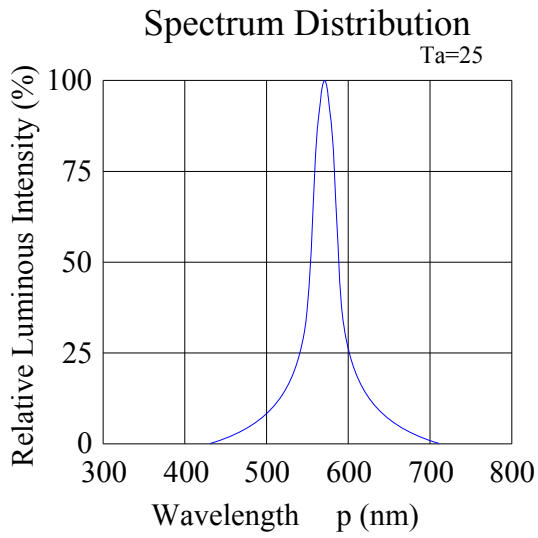

Forward Current Derating Curve

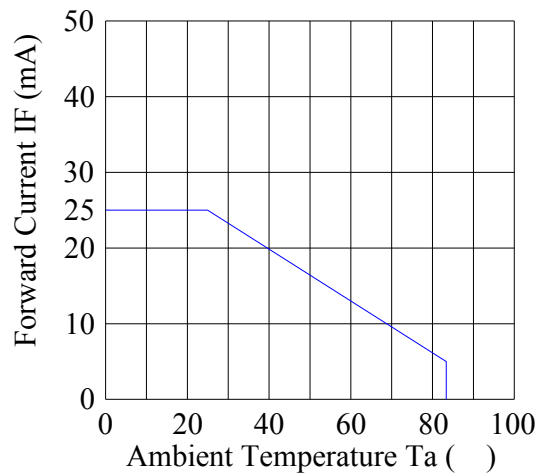

Reliability Test Items And Conditions:

The reliability of products shall be satisfied with items listed below:

Confidence level: 90%.

LTPD: 10%.

No.	Test Item	Test Hours/ Cycles	Test Conditions	Failure Judgment Criteria	Sample Size	Ac/Re
1	Solder Heat	5 SEC	TEMP.: 260 ± 5	$IV \leq IV_t \times 0.5$ or $VF \geq U$ or $VF \leq L$	76 PCS	0/1
2	Temperature Cycle	50 CYCLE	H: +85 30min ∫ 5 min L: -55 30min		76 PCS	0/1
3	Thermal Shock	50 CYCLE	H: +100 5min ∫ 10 sec L: -10 5min		76 PCS	0/1
4	High Temperature Storage	1000 HRS	TEMP.: 100		76 PCS	0/1
5	Low Temperature Storage	1000 HRS	TEMP.: -55		76 PCS	0/1
6	DC Operating Life	1000 HRS	IF=10mA		76 PCS	0/1
7	High Temperature / High Humidity	1000 HRS	85 /85% RH		76 PCS	0/1

Notes:

IV_t: The test IV value of the chip before the reliability test.

IV: The test value of the chip that has completed the reliability test.

U: Upper Specification Limit.

L: Lower Specification Limit.

Soldering iron:

Basic spec is ≤ 5 sec when 260 . If temperature is higher, time should be shorter (+10 \rightarrow -1sec). Power dissipation of iron should be smaller than 15W, and temperature should be controllable. Surface temperature of the device should be under 230 .

Rework:

Customer must finish rework within 5 sec under 260 .

The head of iron can not touch copper foil.

Reflow temperature / time:

Reflow Temperature / Time

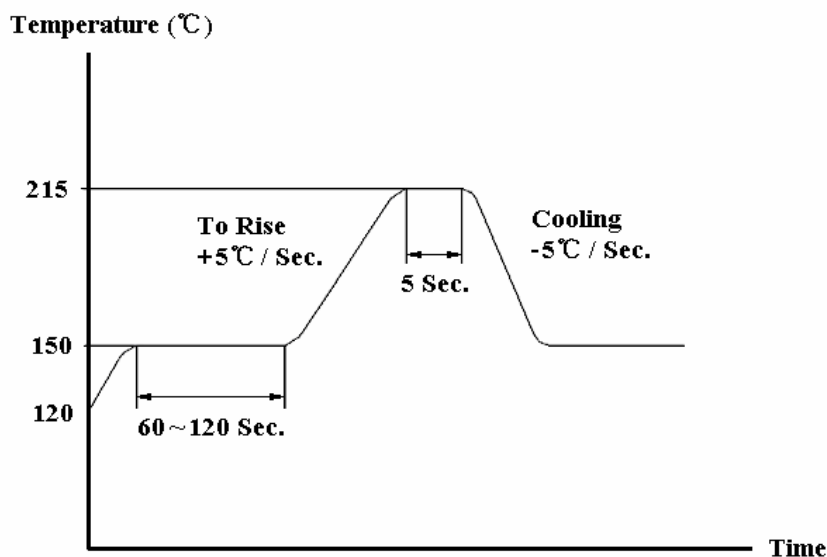

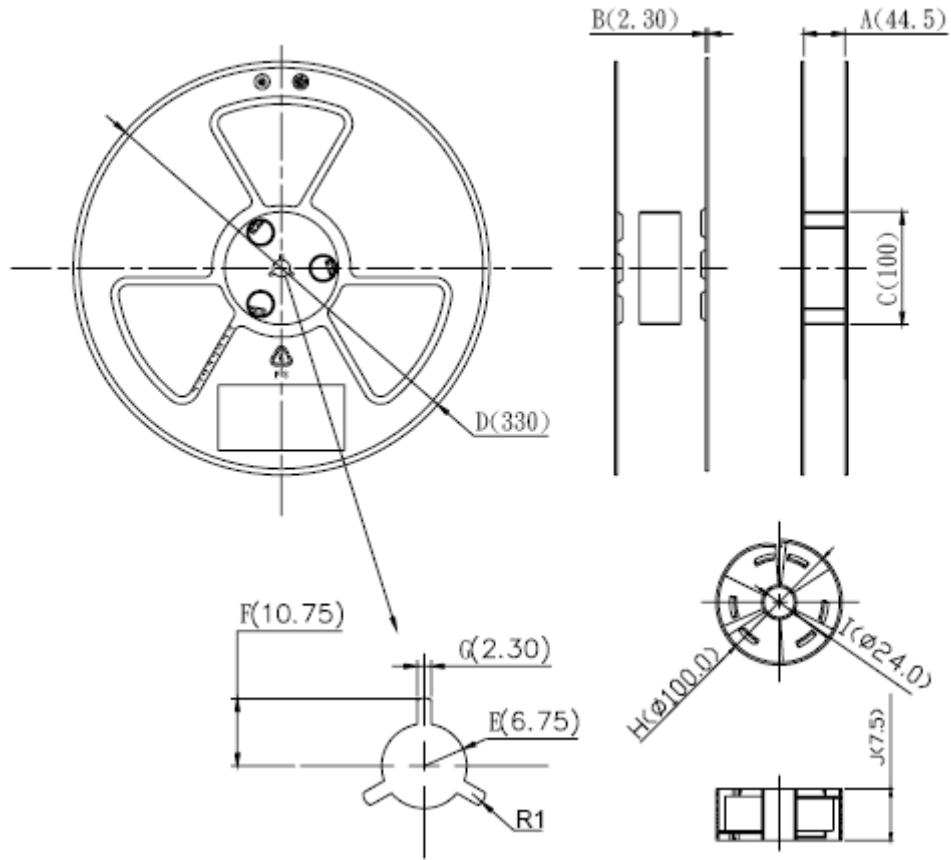
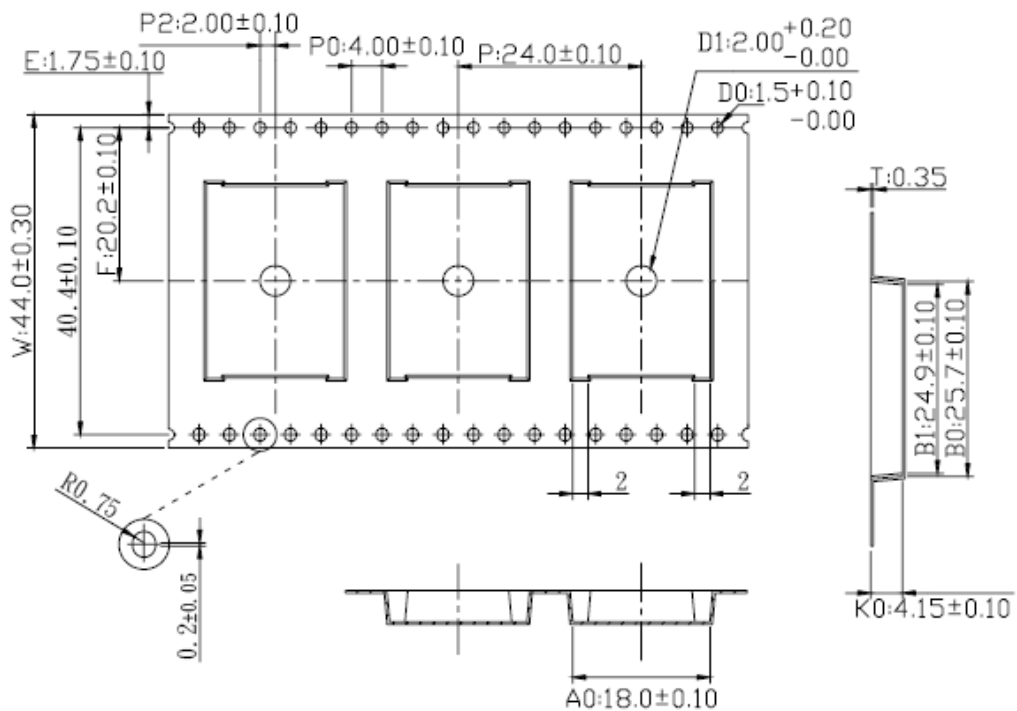
Package Dimensions:

Tape Dimensions:

Please read the following notes before using the product:

1. Over-current-proof

Customer must apply resistors for protection, otherwise slight voltage shift will cause big current change (Burn out will happen).

2. Storage

2.1 Do not open moisture proof bag before the products are ready to use.

2.2 Before opening the package, the LEDs should be kept at 30 °C or less and 90%RH or less.

2.3 The LEDs should be used within a year.

2.4 After opening the package, the LEDs should be kept at 30 °C or less and 70%RH or less.

3. Soldering Condition

3.1 Pb-free solder temperature profile.

3.2 Reflow soldering should not be done more than two times.

4. Soldering Iron

Each terminal is to go to the tip of soldering iron temperature less than 260 °C for 5 seconds within once in less than the soldering iron capacity 25W. Leave two seconds and more intervals, and do soldering of each terminal. Be careful because the damage of the product is often started at the time of the hand solder.

5. Repairing

Repair should not be done after the LEDs have been soldered. When repairing is unavoidable, a double-head soldering iron should be used. It should be confirmed beforehand whether the characteristics of the LEDs will or will not be damaged by repairing.

6. Caution in ESD

Static Electricity and surge damages the LED. It is recommended to use a wrist band or anti-electrostatic glove when handling the LED. All devices equipment and machinery must be properly grounded.