

5mm Bi-Color With Common Cathode Type
Hi-Eff Red & Yellow Green LED
Technical Data Sheet

Part No.: 509IGM2E-I1-2A

Features:

Hi-Eff Red and Yellow Green chips are matched for uniform light output.
Common Cathode.
Long life solid state reliability.
Low power consumption.
I.C. compatible.
The product itself will remain within RoHS complaint Version.

Descriptions:

The lamp contain two integral chips and is available bicolor.
The Hi-Eff Red and Yellow Green light is emitted by diodes of GaAsP/GaP and GaP respectively.
White Diffused lens color.

Applications:

TV set.
Monitor.
Telephone.
Computer.
Circuit board.

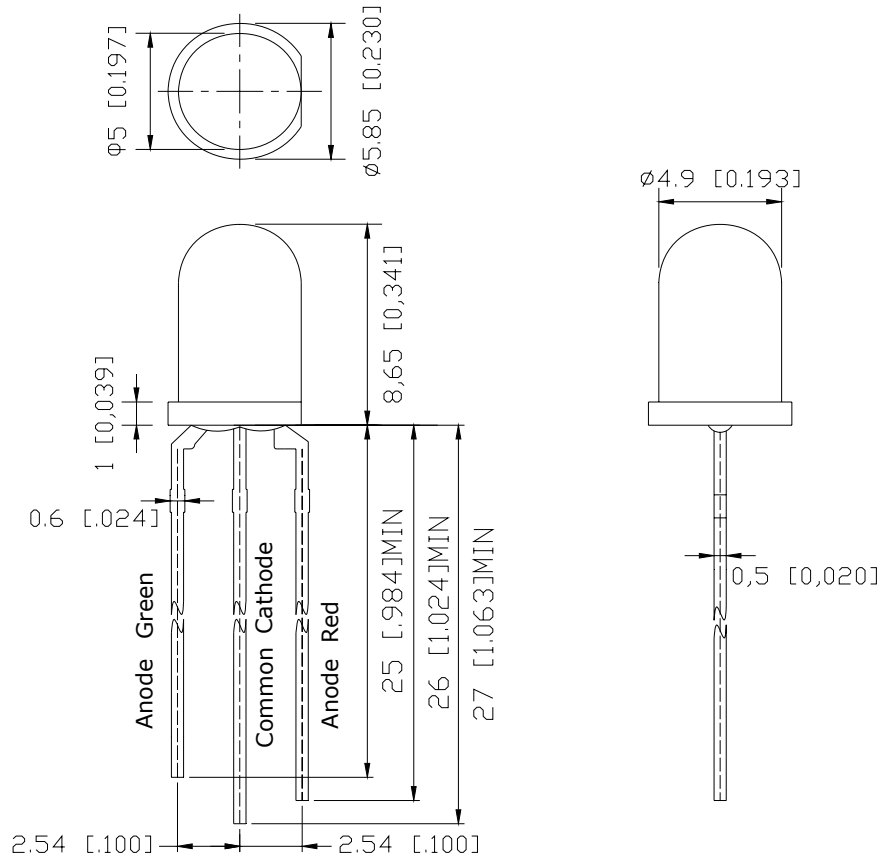
Package Dimension:

Part No.	Chip Material		Lens Color	Source Color
509IGM2E-I1-2A	I	GaAsP/GaP	White Diffused	Hi-Eff Red
	G	GaP		Yellow Green

Notes:

1. All dimensions are in millimeters (inches).
2. Tolerance is $\pm 0.25\text{mm}$ (.010") unless otherwise noted.
3. Protruded resin under flange is 1.00mm (.039") max.
4. Specifications are subject to change without notice.

Absolute Maximum Ratings at Ta=25

Parameters		Symbol	Max.	Unit
Power Dissipation	Red	PD	78	mW
	Yellow Green		78	
Peak Forward Current (1/10 Duty Cycle, 0.1ms Pulse Width)		IFP	100	mA
Red Chip Forward Current		IF	30	mA
Yellow Green Chip Forward Current		IF	30	mA
Reverse Voltage		VR	5	V
Electrostatic Discharge (HBM)	Red	ESD	2000	V
	Yellow Green	ESD	2000	V
Operating Temperature Range		Topr	-40 to +85	
Storage Temperature Range		Tstg	-40 to +100	
Lead Soldering Temperature [4mm (.157") From Body]		Tsld	260 for 5 Seconds	

Electrical Optical Characteristics at Ta=25

Parameters	Symbol	Emitting Color	Min.	Typ.	Max.	Unit	Test Condition
Luminous Intensity *	IV	Red	13	20	---	mcd	IF=20mA (Note 1)
		Yellow Green	20	30	---		
Viewing Angle *	$2\theta_{1/2}$	Red	---	60	---	Deg	IF=20mA (Note 2)
		Yellow Green	---	60	---		
Peak Emission Wavelength	λ_p	Red	---	645	---	nm	IF=20mA
		Yellow Green	---	565	---		
Dominant Wavelength	λ_d	Red	---	630	---	nm	IF=20mA (Note 3)
		Yellow Green	---	570	---		
Forward Voltage	VF	Red	1.60	2.00	2.60	V	IF=20mA
		Yellow Green	1.60	2.20	2.60		
Reverse Current	IR	Red	---	---	10	μ A	$V_R=5V$
		Yellow Green	---	---	10		

Notes:

1. Luminous Intensity Measurement allowance is $\pm 10\%$.
2. $\theta_{1/2}$ is the off-axis angle at which the luminous intensity is half the axial luminous intensity.
3. The dominant wavelength (λ_d) is derived from the CIE chromaticity diagram and represents the single wavelength which defines the color of the device.

Typical Electrical / Optical Characteristics Curves
(25 Ambient Temperature Unless Otherwise Noted)

Red:

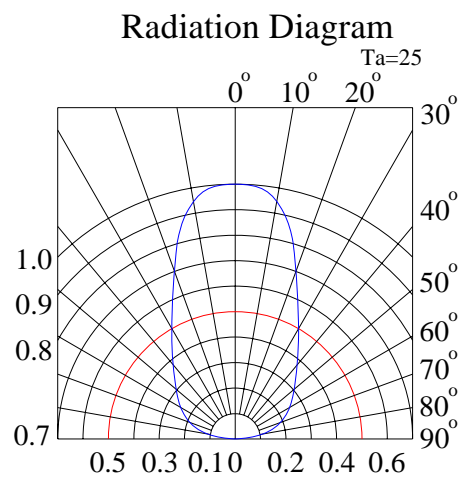
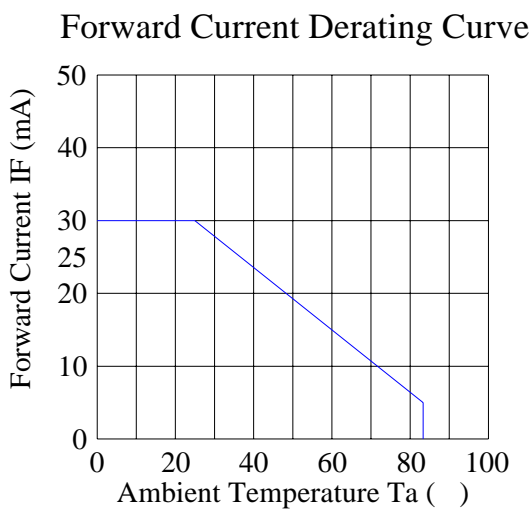
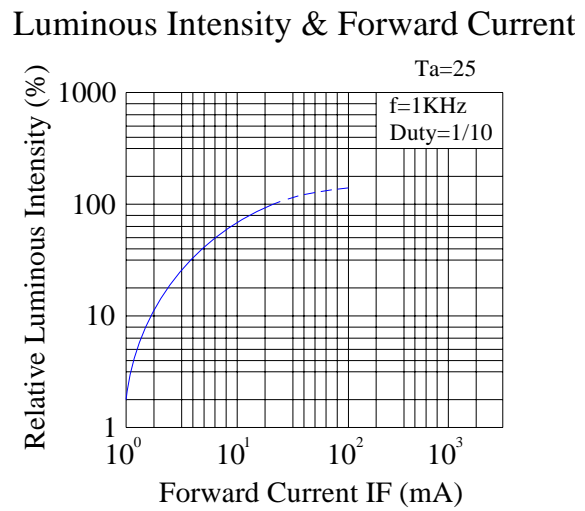
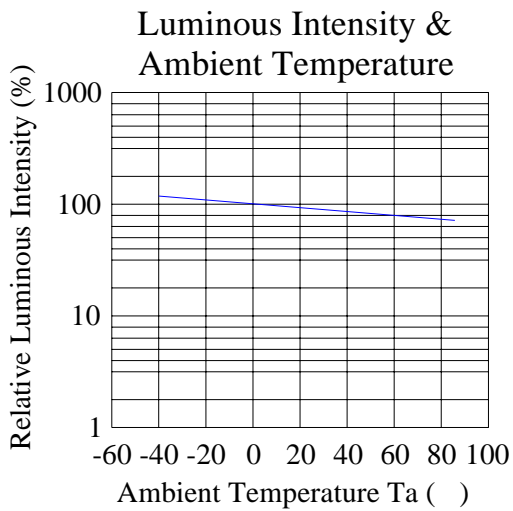
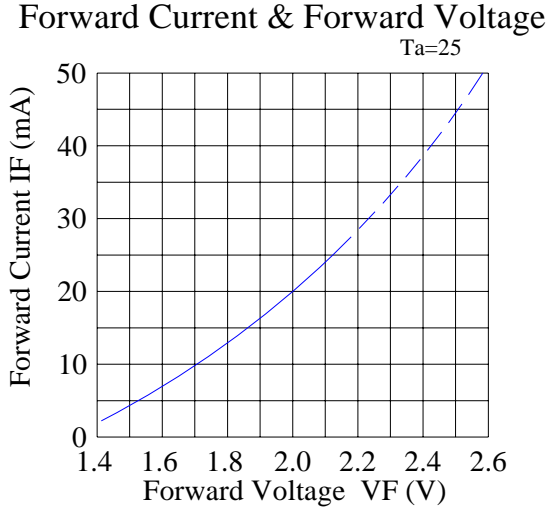
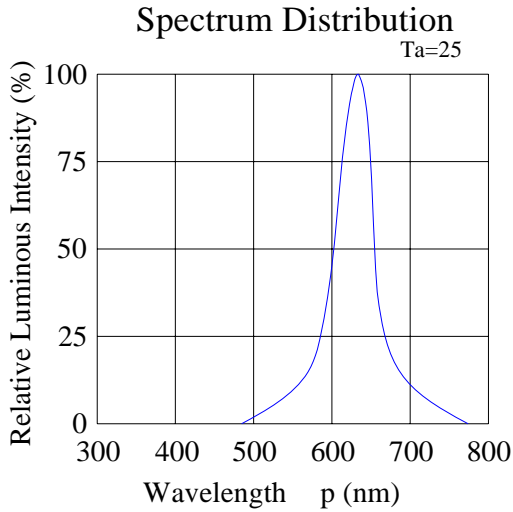

Green:

Spectrum Distribution

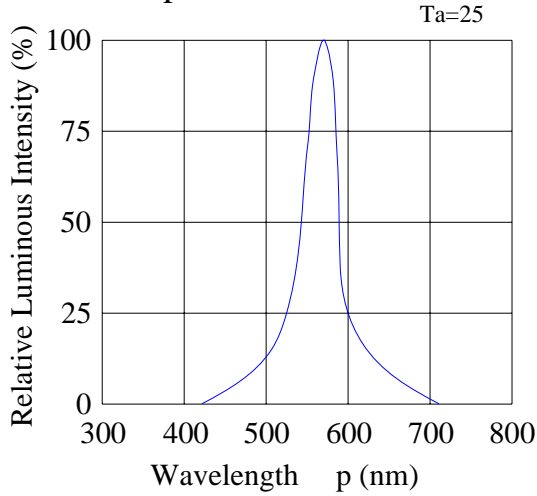

Forward Current & Forward Voltage

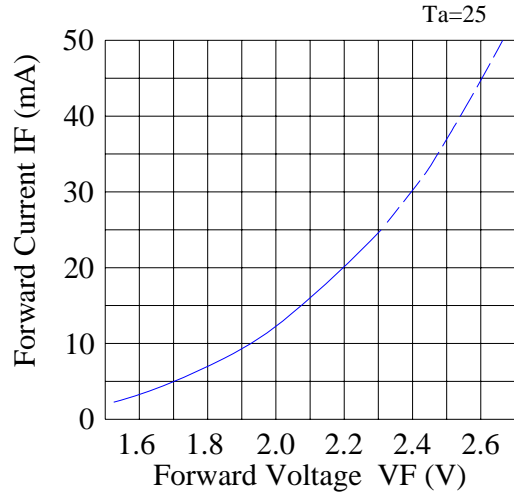

Luminous Intensity & Ambient Temperature

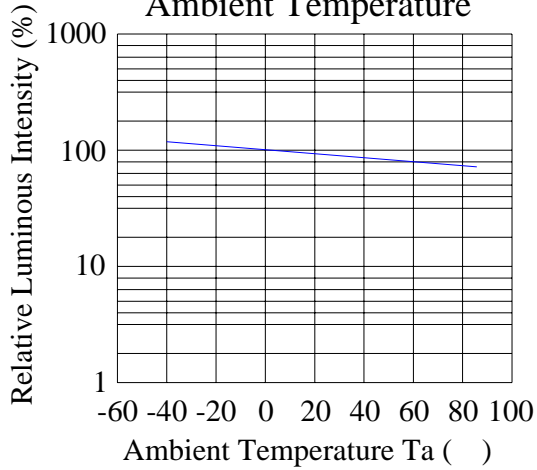

Luminous Intensity & Forward Current

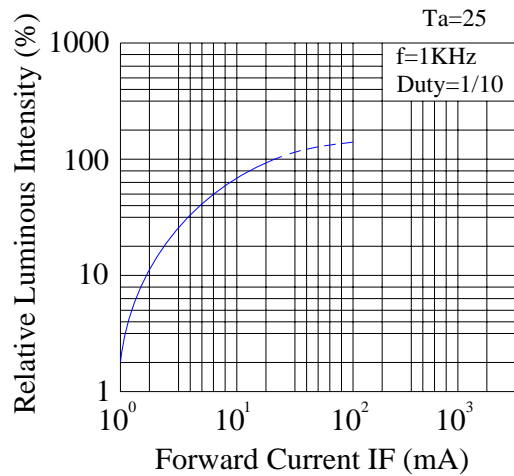

Forward Current Derating Curve

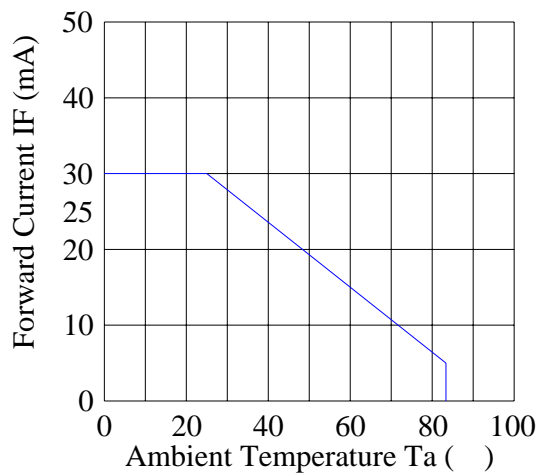

Radiation Diagram

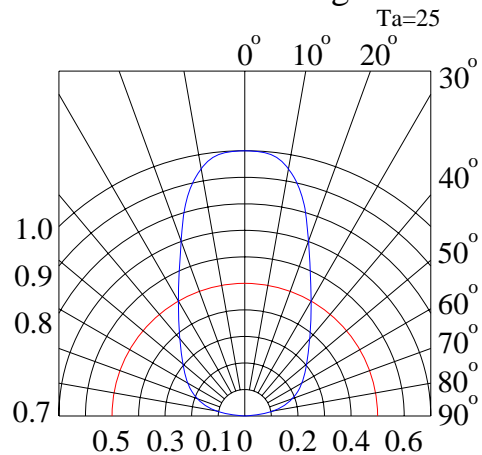

Reliability Test Items And Conditions:

The reliability of products shall be satisfied with items listed below:

Confidence level: 90%.

LTPD: 10%.

1) Test Items and Results:

Test Item	Standard Test Method	Test Conditions	Note	Number of Damaged
Resistance to Soldering Heat	JEITA ED-4701 300 302	Tsld=260±5 , 10sec 3mm from the base of the epoxy bulb	1 time	0/100
Solder ability	JEITA ED-4701 300 303	Tsld=235±5 , 5sec(using flux)	1time over 95%	0/100
Thermal Shock	JEITA ED-4701 300 307	0 ~100 15sec, 15sec	100 cycles	0/100
Temperature Cycle	JEITA ED-4701 100 105	-40 ~25 ~100 ~25 30min,5min,30min,5min	100 cycles	0/100
Moisture Resistance Cycle	JEITA ED-4701 200 203	25 ~65 ~-10 90%RH 24hrs/1cycle	10 cycles	0/100
High Temperature Storage	JEITA ED-4701 200 201	Ta=100	1000hrs	0/100
Terminal Strength (Pull test)	JEITA ED-4701 400 401	Load 10N (1kgf) 10±1sec	No noticeable damage	0/100
Terminal Strength (bending test)	JEITA ED-4701 400 401	Load 5N (0.5kgf) 0°~90°~0° bend 2 times	No noticeable damage	0/100
Temperature Humidity Storage	JEITA ED-4701 100 103	Ta=60 , RH=90%	1000hrs	0/100
Low Temperature Storage	JEITA ED-4701 200 202	Ta=-40	1000hrs	0/100
Steady State Operating Life		Ta=25 , IF=30mA	1000hrs	0/100
Steady State Operating Life of High Humidity Heat		Ta=60 , RH=90%, IF=30mA	500hrs	0/100
Steady State Operating Life of Low Temperature		Ta=-30 , IF=30mA	1000hrs	0/100

2) Criteria For Judging The Damage:

Item	Symbol	Test Conditions	Criteria for Judgment	
			Min	Max
Forward Voltage	VF	IF=20mA	---	F.V.*)×1.1
Reverse Current	IR	VR=5V	---	F.V.*)×2.0
Luminous Intensity	IV	IF=20mA	F.V.*)×0.7	---

*) F.V.: First Value.

Please read the following notes before using the product:

1. Over-current-proof

Customer must apply resistors for protection, otherwise slight voltage shift will cause big current change (Burn out will happen).

2. Storage

2.1 Do not open moisture proof bag before the products are ready to use.

2.2 Before opening the package, the LEDs should be kept at 30 °C or less and 80%RH or less.

2.3 The LEDs should be used within a year.

2.4 After opening the package, the LEDs should be kept at 30 °C or less and 60%RH or less.

2.5 The LEDs should be used within 168 hours (7 days) after opening the package.

3. Soldering Iron

Each terminal is to go to the tip of soldering iron temperature less than 260 °C for 5 seconds within once in less than the soldering iron capacity 25W. Leave two seconds and more intervals, and do soldering of each terminal. Be careful because the damage of the product is often started at the time of the hand solder.

4. Soldering

When soldering, for Lamp without stopper type and must be leave a minimum of 3mm clearance from the base of the lens to the soldering point.

To avoided the Epoxy climb up on lead frame and was impact to non-soldering problem, dipping the lens into the solder must be avoided.

Do not apply any external stress to the lead frame during soldering while the LED is at high temperature.

Recommended soldering conditions:

Soldering Iron		Wave Soldering	
Temperature	300 Max.	Pre-heat	100 Max.
Soldering Time	3 sec. Max. (one time only)	Pre-heat Time	60 sec. Max.
		Solder Wave	260 Max.
		Soldering Time	5 sec. Max.

Note: Excessive soldering temperature and / or time might result in deformation of the LED lens or catastrophic failure of the LED.

5. Repairing

Repair should not be done after the LEDs have been soldered. When repairing is unavoidable, a double-head soldering iron should be used. It should be confirmed beforehand whether the characteristics of the LEDs will or will not be damaged by repairing.

6. Caution in ESD

Static Electricity and surge damages the LED. It is recommended to use a wrist band or anti-electrostatic glove when handling the LED. All devices equipment and machinery must be properly grounded.