

1.50" Single Digit Numeric Displays
Technical Data Sheet

Model No.: KW1-1501XPGB

Features:

- ◇ 1.50" (inch) digit height.
- ◇ Excellent segment uniformity.
- ◇ Sold state reliability.
- ◇ Industrial standard size.
- ◇ Low power consumption.
- ◇ The product itself will remain within RoHS compliant Version.

Descriptions:

- ◇ The KW1-1501XXX series is a larger 38.10mm (1.50") high seven segments display designed for viewing distances up to 7 meters.
- ◇ These displays provide excellent reliability in bright ambient light.
- ◇ These devices are made with white segments and black surface.

Applications:

- ◇ Audio equipment.
- ◇ Instrument panels.
- ◇ Digital read out display.

Device Selection Guide:

| Model No. | Chip Material | Source Color | Description |
|--------------|---------------|--------------|----------------|
| KW1-1501CPGB | InGaN | Pure Green | Common Cathode |
| KW1-1501APGB | | Pure Green | Common Anode |

Package Dimension:

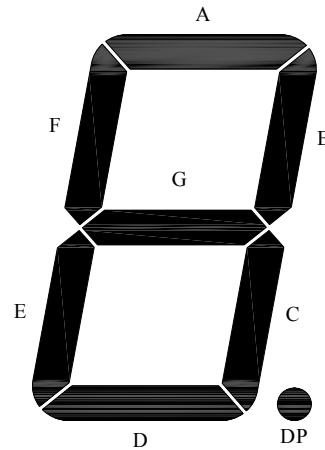
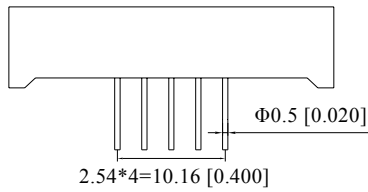
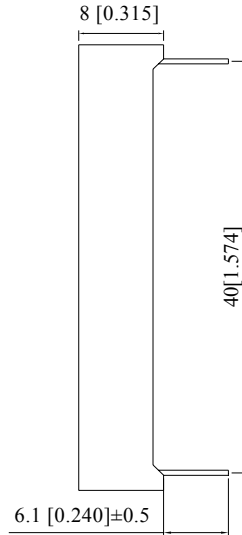
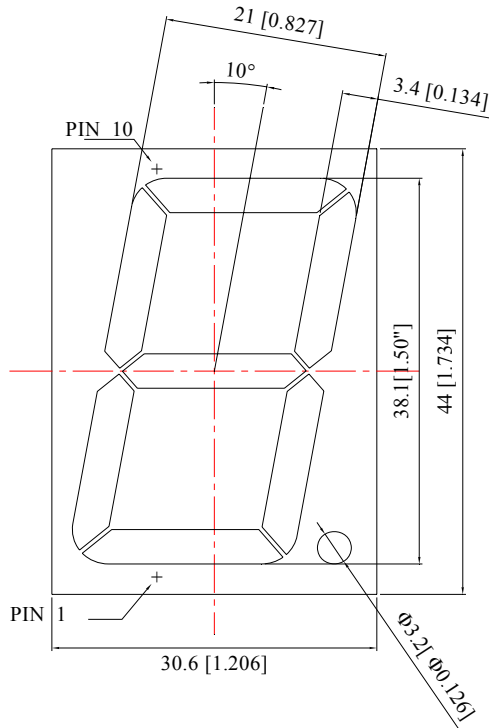

KW1-1501CPGB

KW1-1501APGB

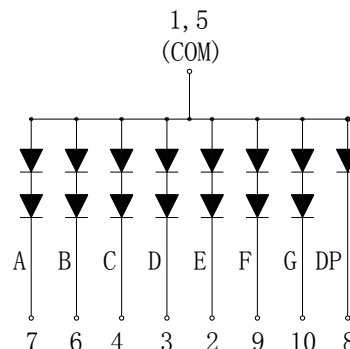
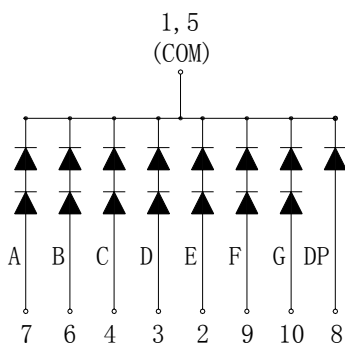

Notes:

1. All dimensions are in millimeters (inches).
2. Tolerance is ± 0.25 mm (.010") unless otherwise noted.
3. Specifications are subject to change without notice.

Absolute Maximum Ratings at Ta=25°C

| Parameters | Symbol | Max. | Unit |
|--|--------|---------------------|-------|
| Power Dissipation Per Segment | PD | 200 | mW |
| Peak Forward Current Per Segment (1/10 Duty Cycle, 0.1ms Pulse Width) | IFP | 100 | mA |
| Forward Current Per Segment | IF | 25 | mA |
| Dating Linear From 50°C | | 0.4 | mA/°C |
| Reverse Voltage | VR | 5 | V |
| Operating Temperature Range | Topr | -40°C to +80°C | |
| Storage Temperature Range | Tstg | -40°C to +85°C | |
| Soldering Temperature | Tsld | 260°C for 5 Seconds | |

Electrical Optical Characteristics at Ta=25°C

| Parameters | Symbol | Min. | Typ. | Max. | Unit | Test Condition |
|---|------------------|------|------|------|------|------------------|
| Luminous Intensity | Iv | 25 | 50 | --- | mcd | IF=20mA (Note 1) |
| Luminous Intensity Matching Ratio (Segment To Segment) | I _{v-m} | --- | --- | 2:1 | | IF=10mA |
| Peak Emission Wavelength | λp | --- | 520 | --- | nm | IF=20mA |
| Dominant Wavelength | λd | --- | 525 | --- | nm | IF=20mA (Note 2) |
| Spectral Line Half-Width | Δλ | --- | 35 | --- | nm | IF=20mA |
| Forward Voltage | VF | --- | 6.4 | 8.0 | V | IF=20mA |
| Reverse Current | IR | --- | --- | 50 | μA | VR=5V |

Notes:

1. Luminous intensity is measured with a light sensor and filter combination that approximates the CIE eye-response curve.
2. The dominant wavelength (λd) is derived from the CIE chromaticity diagram and represents the single wavelength which defines the color of the device.

Typical Electrical / Optical Characteristics Curves
(25°C Ambient Temperature Unless Otherwise Noted)

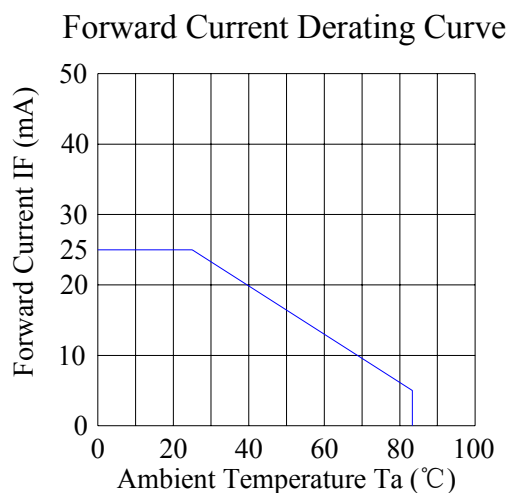
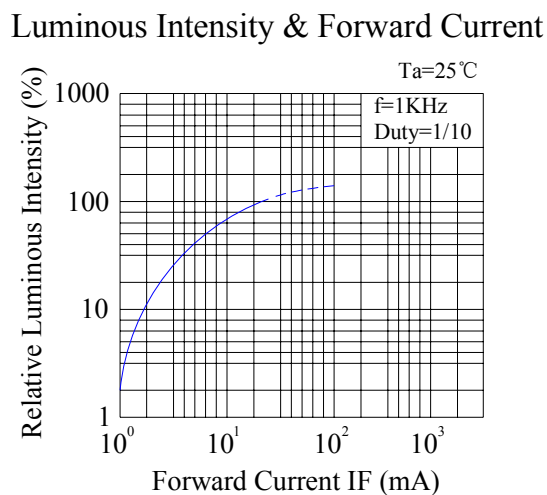
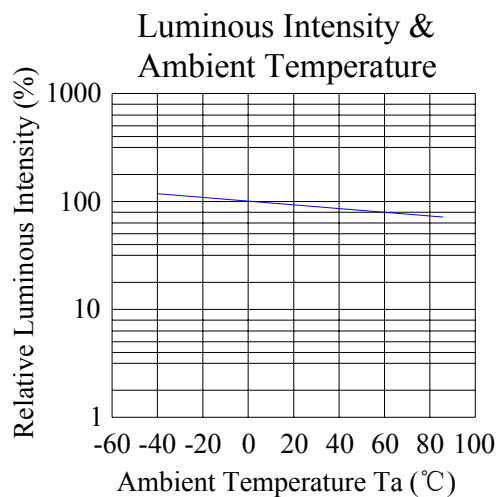
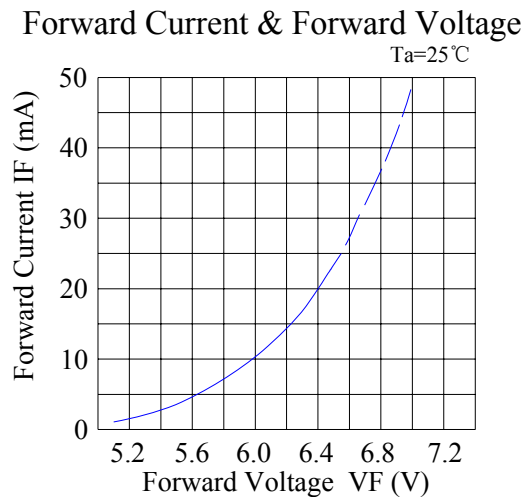
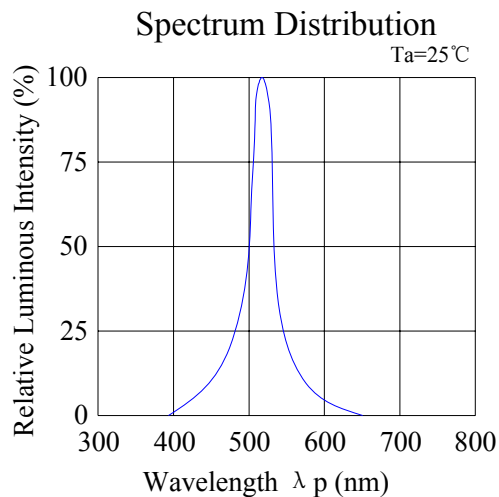

Please read the following notes before using the datasheets:

1. Over-current-proof

Customer must apply resistors for protection, otherwise slight voltage shift will cause big current change (Burn out will happen).

2. Storage

2.1 If the package contains a moisture proof bag inside, please don't open the package before using.

2.2 Before opening the package, the LEDs should be kept at 30°C or less and 80%RH or less.

2.3 The LEDs should be used within a year.

2.4 After opening the package, the LEDs should be kept at 30°C or less and 60%RH or less.

3. Soldering Iron

Each terminal is to go to the tip of soldering iron temperature less than 260°C for 5 seconds within once in less than the soldering iron capacity 25W. Leave two seconds and more intervals, and do soldering of each terminal. Be careful because the damage of the product is often started at the time of the hand solder.

4. Soldering

When soldering, for Lamp without stopper type and must be leave a minimum of 3mm clearance from the base of the lens to the soldering point.

To avoided the Epoxy climb up on lead frame and was impact to non-soldering problem, dipping the lens into the solder must be avoided.

Do not apply any external stress to the lead frame during soldering while the LED is at high temperature.

Recommended soldering conditions:

| Soldering Iron | | Wave Soldering | |
|----------------|--------------------------------|----------------|--------------|
| Temperature | 300°C Max. | Pre-heat | 100°C Max. |
| Soldering Time | 3 sec. Max. (one time only) | Pre-heat Time | 60 sec. Max. |
| | | Solder Wave | 260°C Max. |
| | | Soldering Time | 5 sec. Max. |

Note: Excessive soldering temperature and / or time might result in deformation of the LED lens or catastrophic failure of the LED.

5. Repairing

Repair should not be done after the LEDs have been soldered. When repairing is unavoidable, a double-head soldering iron should be used. It should be confirmed beforehand whether the characteristics of the LEDs will or will not be damaged by repairing.

6. Caution in ESD

Static Electricity and surge damages the LED. It is recommended to use a wrist band or anti-electrostatic glove when handling the LED. All devices equipment and machinery must be properly grounded.