

4.0" Single Digit Numeric Displays  
Technical Data Sheet

Model No.: KW1-4001XSB

## Features:

- ◇ 4.0"(inch) digit height.
- ◇ Excellent segment uniformity.
- ◇ Sold state reliability.
- ◇ Industrial standard size.
- ◇ Low power consumption.
- ◇ The product itself will remain within RoHS compliant Version.

## Descriptions:

- ◇ The KW1-4001XXX series is a larger 101.6mm(4.0") high seven segments display designed for viewing distances up to 7 meters.
- ◇ These displays provide excellent reliability in bright ambient light.
- ◇ These devices are made with white segments and black surface.

## Applications:

- ◇ Audio equipment.
- ◇ Instrument panels.
- ◇ Digital read out display.

## Device Selection Guide:

Model No.	Chip Material	Source Color	Description
KW1-4001ASB	GaAlAs	Super Red	Common Anode
KW1-4001CSB		Super Red	Common Cathode

### Package Dimension:

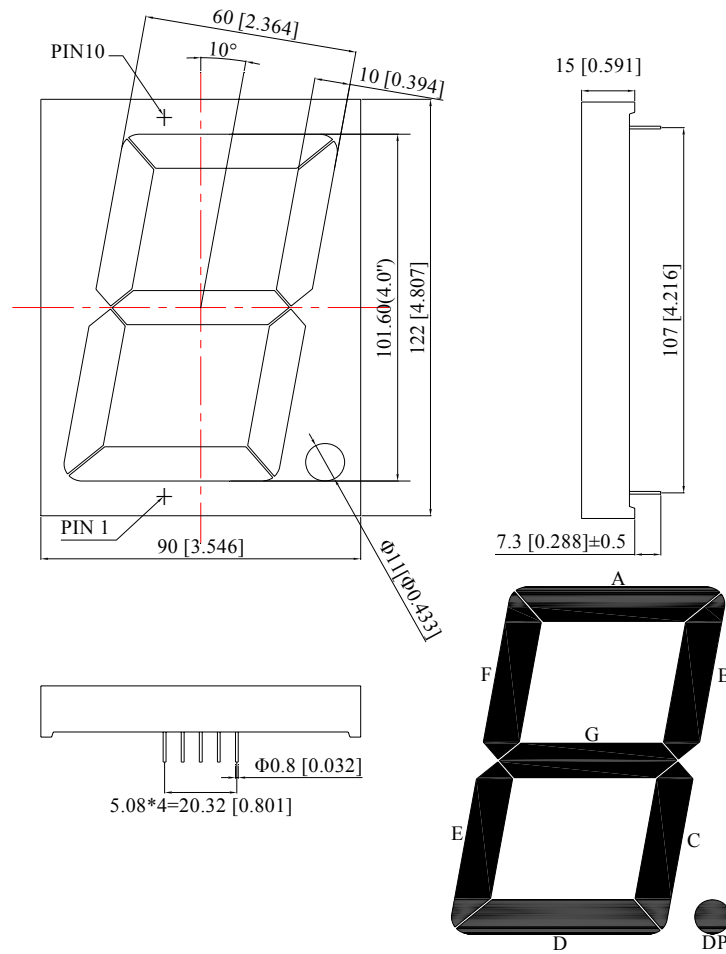

**KW1-4001ASB**

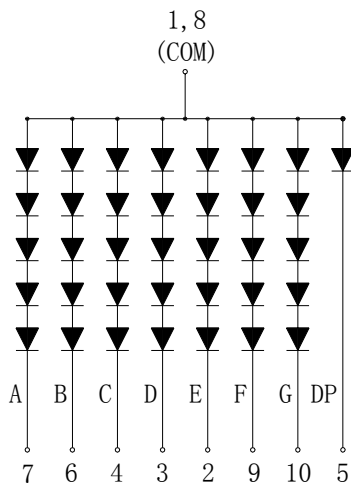

**KW1-4001CSB**

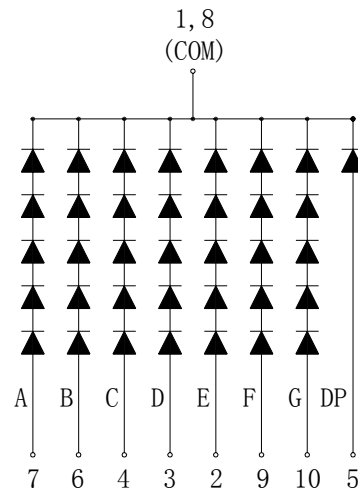

### Notes:

1. All dimensions are in millimeters (inches).
2. Tolerance is  $\pm 0.25$  (.010") mm unless otherwise noted.
3. Specifications are subject to change without notice.

### Absolute Maximum Ratings at Ta=25°C

Parameters	Symbol	Max.	Unit
Power Dissipation Per Segment	PD	300	mW
Peak Forward Current Per Segment (1/10 Duty Cycle, 0.1ms Pulse Width)	IFP	100	mA
Forward Current Per Segment	IF	25	mA
Derating Linear From 50°C		0.4	mA/°C
Reverse Voltage	VR	5	V
Operating Temperature Range	Topr	-40°C to +80°C	
Storage Temperature Range	Tstg	-40°C to +85°C	
Soldering Temperature	Tsld	260°C for 5 Seconds	

### Electrical Optical Characteristics at Ta=25°C

Parameters	Symbol	Min.	Typ.	Max.	Unit	Test Condition
Luminous Intensity	Iv	9.0	18.0	---	mcd	IF=20mA (Note 1)
Luminous Intensity Matching Ratio (Segment To Segment)	Iv-m	---	---	2:1		IF=10mA
Peak Emission Wavelength	$\lambda_p$	---	660	---	nm	IF=20mA
Dominant Wavelength	$\lambda_d$	---	640	---	nm	IF=20mA (Note 2)
Spectral Line Half-Width	$\Delta\lambda$	---	20	---	nm	IF=20mA
Forward Voltage	VF	---	9.0	12.0	V	IF=20mA
Reverse Current	IR	---	---	50	$\mu$ A	VR=5V

#### Notes:

1. Luminous intensity is measured with a light sensor and filter combination that approximates the CIE eye-response curve.
2. The dominant wavelength ( $\lambda_d$ ) is derived from the CIE chromaticity diagram and represents the single wavelength which defines the color of the device.

Typical Electrical / Optical Characteristics Curves  
(25°C Ambient Temperature Unless Otherwise Noted)

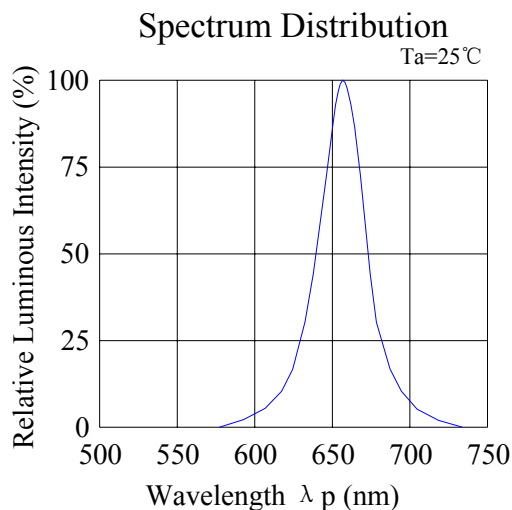

### Forward Current & Forward Voltage

Ta=25°C

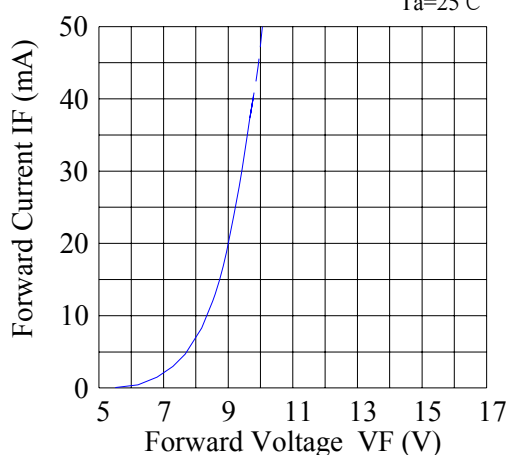

### Forward Current Derating Curve

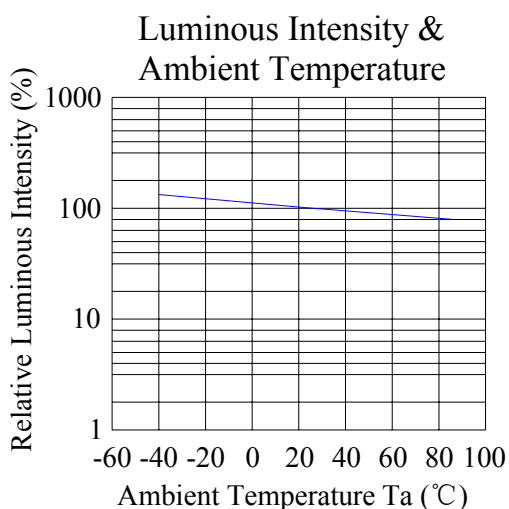
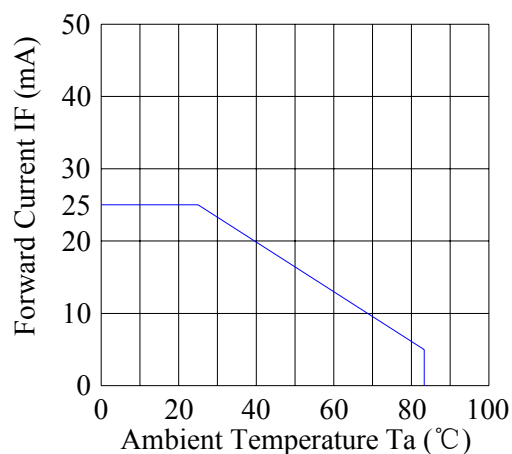

### Luminous Intensity & Forward Current

Ta=25°C

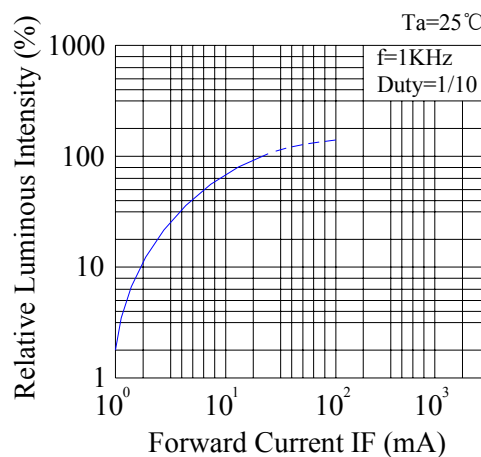

Please read the following notes before using the datasheets:

1. Over-current-proof

Customer must apply resistors for protection, otherwise slight voltage shift will cause big current change (Burn out will happen).

2. Storage

2.1 If the package contains a moisture proof bag inside, please don't open the package before using.

2.2 Before opening the package, the LEDs should be kept at 30°C or less and 80%RH or less.

2.3 The LEDs should be used within a year.

2.4 After opening the package, the LEDs should be kept at 30°C or less and 60%RH or less.

3. Soldering Iron

Each terminal is to go to the tip of soldering iron temperature less than 260°C for 5 seconds within once in less than the soldering iron capacity 25W. Leave two seconds and more intervals, and do soldering of each terminal. Be careful because the damage of the product is often started at the time of the hand solder.

4. Soldering

When soldering, for Lamp without stopper type and must be leave a minimum of 3mm clearance from the base of the lens to the soldering point.

To avoided the Epoxy climb up on lead frame and was impact to non-soldering problem, dipping the lens into the solder must be avoided.

Do not apply any external stress to the lead frame during soldering while the LED is at high temperature.

Recommended soldering conditions:

Soldering Iron		Wave Soldering	
Temperature	300°C Max.	Pre-heat	100°C Max.
Soldering Time	3 sec. Max. (one time only)	Pre-heat Time	60 sec. Max.
		Solder Wave	260°C Max.
		Soldering Time	5 sec. Max.

Note: Excessive soldering temperature and / or time might result in deformation of the LED lens or catastrophic failure of the LED.

5. Repairing

Repair should not be done after the LEDs have been soldered. When repairing is unavoidable, a double-head soldering iron should be used. It should be confirmed beforehand whether the characteristics of the LEDs will or will not be damaged by repairing.