

# 0.5W Red High Power LED

## Technical Data Sheet

Part No.: HP30MVB

## Features:

- Very long operating life (up to 100k hours).
- Available in white, green, blue, red, yellow.
- More energy efficient than incandescent and most halogen lamps.
- Low voltage DC operated.
- Cool beam, safe to the touch.
- Instant light (less than 100 ns).
- The product itself will remain within RoHS compliant Version.

## Applications:

- Reading lights (car, bus, aircraft).
- Portable (flashlight, bicycle).
- Mini\_accent/Uplighters/Downlighters/Orientation.
- Bollards/Security/Garden.
- Cove/Undershelf/Task.
- Automotive rear combination lamps.
- Traffic signaling/Beacons/ Rail crossing and Wayside.
- Indoor/Outdoor Commercial and Residential Architectural.
- Edge\_lit signs (Exit, point of sale).
- LCD Backlights/Light Guides.

### Mechanical Dimensions:

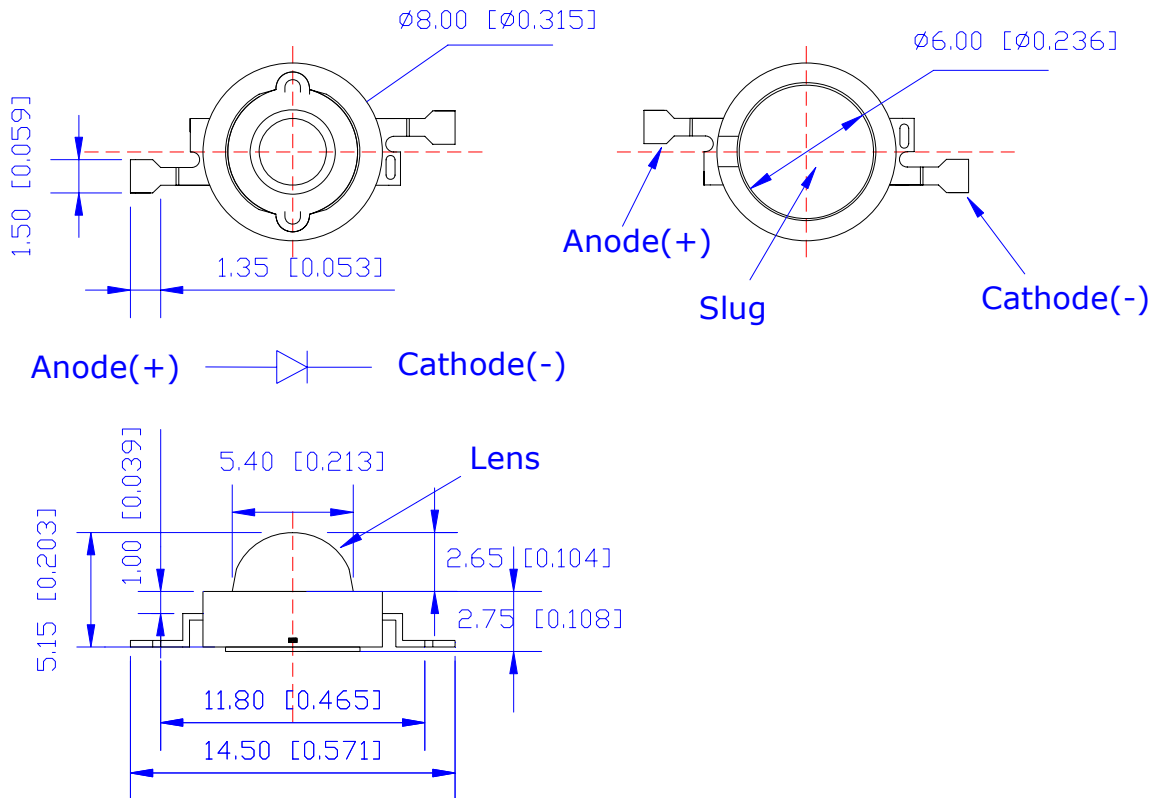

Part No.	Chip Material	Source Color
HP30MVB	AllnGaP	Red

#### Notes:

1. All dimensions are in millimeters.
2. Tolerance is  $\pm 0.25$  mm (.010") unless otherwise noted.
3. Specifications are subject to change without notice.

### Absolute Maximum Ratings at Ta=25

Parameters	Symbol	Rating	Units
Forward Current	IF	150	mA
PeakPulseCurrent (tp≤100μs, Duty cycle=0.25)	I pulse	300	mA
Reverse Voltage	VR	5	V
LED Junction Temperature	Tj	125	
Operating Temperature Range	Topr	-40 to +80	
Storage Temperature Range	Tstg	-40 to +85	
Soldering Time at 260 (Max.)	Tsol	260 for 5 Seconds	

#### Notes:

1. Proper current derating must be observed to maintain junction temperature below the maximum.
2. LEDs are not designed to be driven in reserve bias.

### Electrical Optical Characteristics at Ta=25

Parameters	Symbol	Min.	Typ.	Max.	Unit	Test Condition
Viewing Angle [1]	2θ1/2	---	135	--	Deg	IF=150mA
Forward Voltage [2]	VF	1.60	2.00	2.40	V	IF=150mA
Reverse Current	IR	---	---	10	μA	VR=5V
Peak Emission Wavelength	λp	---	634	---	nm	IF=150mA
Dominant Wavelength	λd	---	624	---	nm	IF =150mA
Spectrum Radiation Bandwidth	Δλ	---	20	---	nm	IF=150mA
Luminous Flux	Φv	12	20	---	lm	IF=150mA

#### Notes:

1. 2θ1/2 is the off axis angle from lamp centerline where the luminous intensity is 1/2 of the peak value.
2. Forward Voltage measurement tolerance : ±0.1V

Typical Electrical-Optical Characteristics Curves  
 (25 Ambient Temperature Unless Otherwise Noted)

**Relative Spectral Distribution**

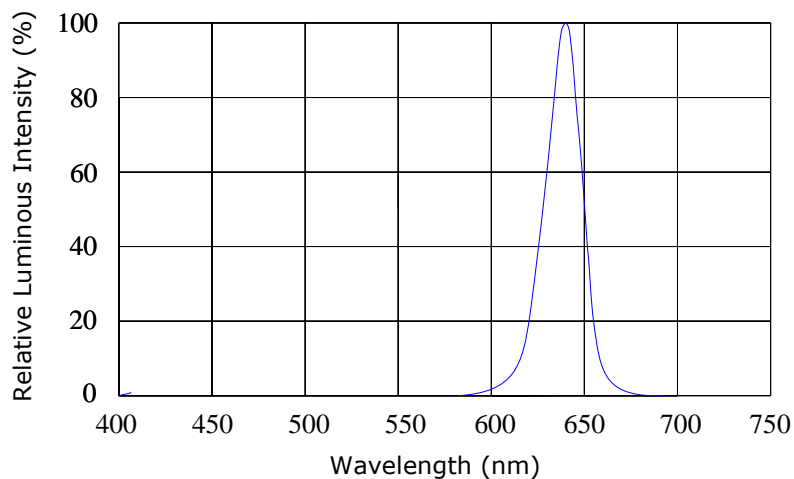

**Forward Current VS Forward Voltage**

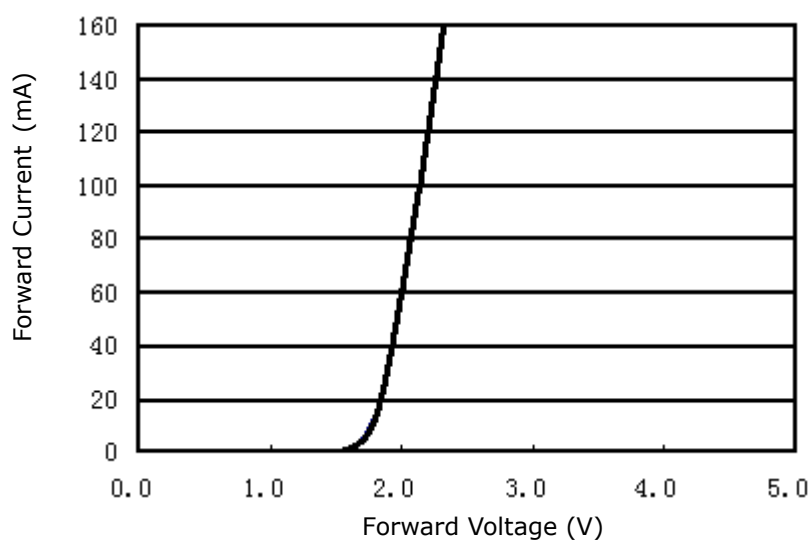

**Luminous Flux VS Forward Current**

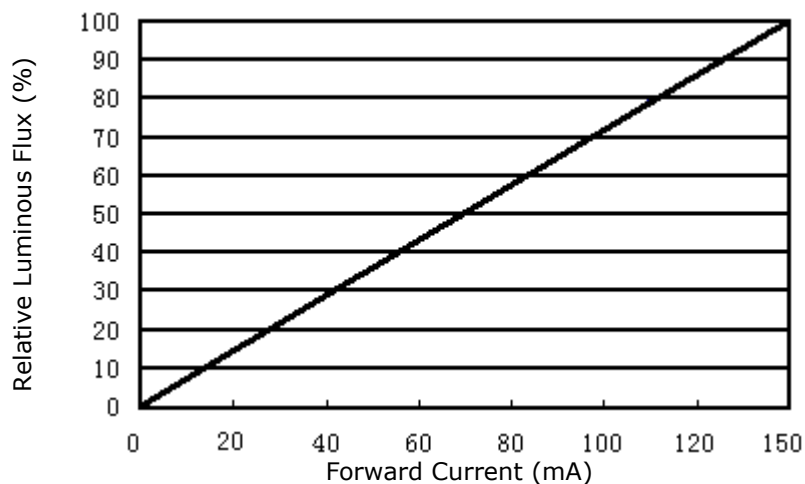

## Typical Electrical-Optical Characteristics Curves

### Maximum Current VS Ambient Temperature

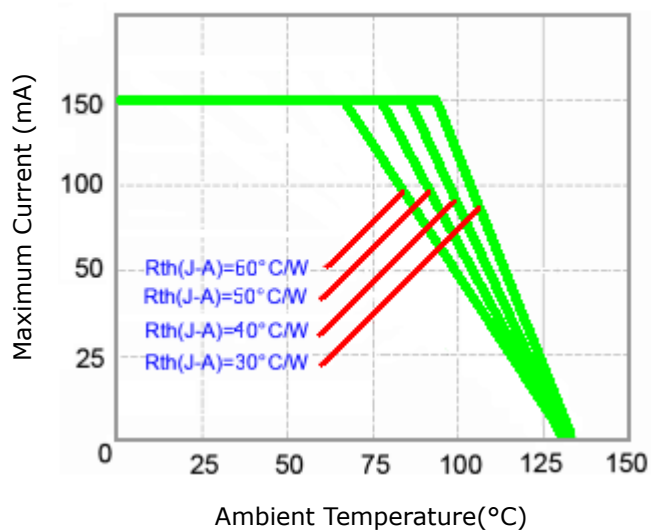

### Typical Spatial Radiation Pattern

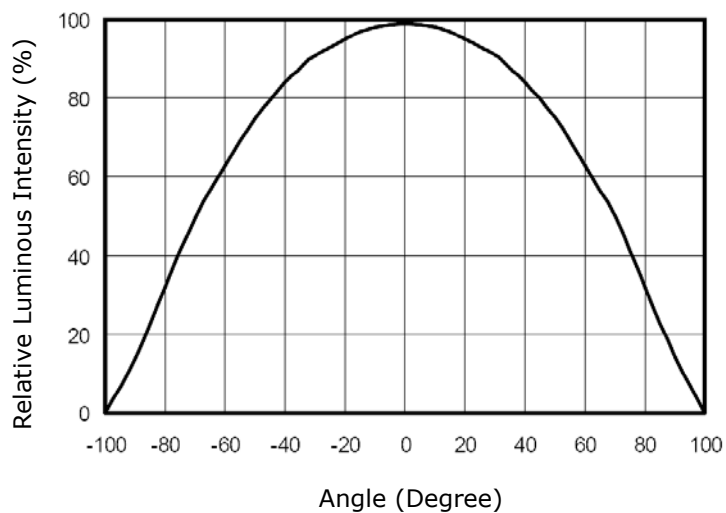

Please read the following notes before using the product:

### 1. Over-current-proof

Customer must apply resistors for protection, otherwise slight voltage shift will cause big current change (Burn out will happen).

### 2. Storage

2.1 Do not open moisture proof bag before the products are ready to use.

2.2 Before opening the package, the LEDs should be kept at 30 °C or less and 80%RH or less.

2.3 The LEDs should be used within a year.

2.4 After opening the package, the LEDs should be kept at 30 °C or less and 60%RH or less.

2.5 The LEDs should be used within 168 hours (7 days) after opening the package.

2.6 If the moisture adsorbent material has fabled away or the LEDs have exceeded the storage time, baking treatment should be performed using the following conditions. Baking treatment: 60±5 °C for 24 hours.

### 3. Soldering Condition

When soldering, for Lamp without stopper type and must be leave a minimum of 3mm clearance from the base of the lens to the soldering point.

To avoided the Epoxy climb up on lead frame and was impact to non-soldering problem, dipping the lens into the solder must be avoided.

Do not apply any external stress to the lead frame during soldering while the LED is at high temperature.

Recommended soldering conditions:

Soldering Iron		Wave Soldering	
Temperature	300 Max.	Pre-heat	100 Max.
Soldering Time	3 sec. Max. (one time only)	Pre-heat Time	60 sec. Max.
		Solder Wave	260 Max.
		Soldering Time	5 sec. Max.

Note: Excessive soldering temperature and / or time might result in deformation of the LED lens or catastrophic failure of the LED.

### 4. Soldering Iron

Each terminal is to go to the tip of soldering iron temperature less than 260 °C for 5 seconds within once in less than the soldering iron capacity 25W. Leave two seconds and more intervals, and do soldering of each terminal. Be careful because the damage of the product is often started at the time of the hand solder.

### 5. Repairing

Repair should not be done after the LEDs have been soldered. When repairing is unavoidable, a double-head soldering iron should be used (as below figure). It should be confirmed beforehand whether the characteristics of the LEDs will or will not be damaged by repairing.

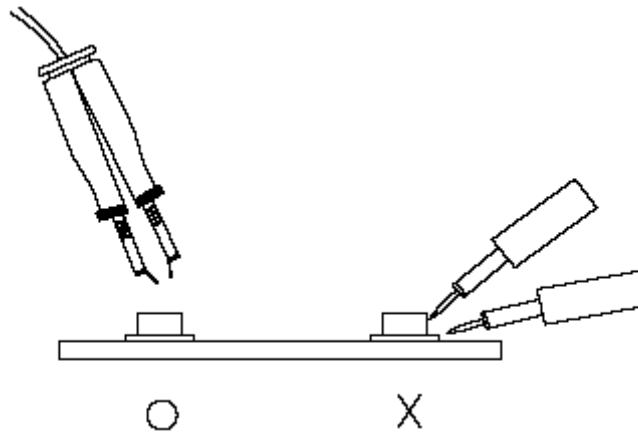

## 6. Caution in ESD

Static Electricity and surge damages the LED. It is recommended to use a wrist band or anti-electrostatic glove when handling the LED. All devices, equipment and machinery must be properly grounded.