

PLCC-2 Package Top View White Chip LED
Technical Data Sheet

Series No.: R3014W-WXM-QXX

Features:

- ◇ PLCC-2 package.
- ◇ White package.
- ◇ Colorless clear window.
- ◇ Wide viewing angle.
- ◇ High luminous and high efficiency.
- ◇ Excellent performans and visibility.
- ◇ Suitable for all SMT assembly methods.
- ◇ Suitable for vapor-phase reflow, Infrared reflow and wave solder processes.
- ◇ Compatible with automatic placement equipment.
- ◇ Available on tape and reel (8mm Tape).
- ◇ The product itself will remain within RoHS compliant Version.

Descriptions:

- ◇ The R3014 series is available in soft green, blue, and white. Due to the package design, the LED has wide viewing angle and optimized. Light coupling by inter reflector. This feature makes the TOP View LEDs ideal for portable equipment or any other application where is at a premium.

Applications:

- ◇ Automotive: Backlight in dashboards and switches.
- ◇ Telecommunication: Indicator and backlight in telephone and fax.
- ◇ Indicator and backlight for audio and video equipment.
- ◇ Indicator and backlight in office and family equipment.
- ◇ Flat backlight for LCD's, switches and symbols.
- ◇ Light pipe application.
- ◇ General use.

Package Dimension:

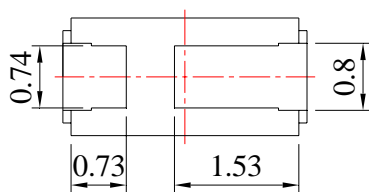
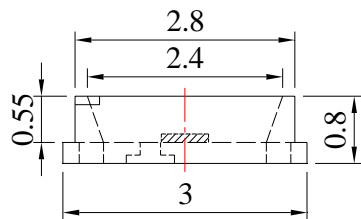
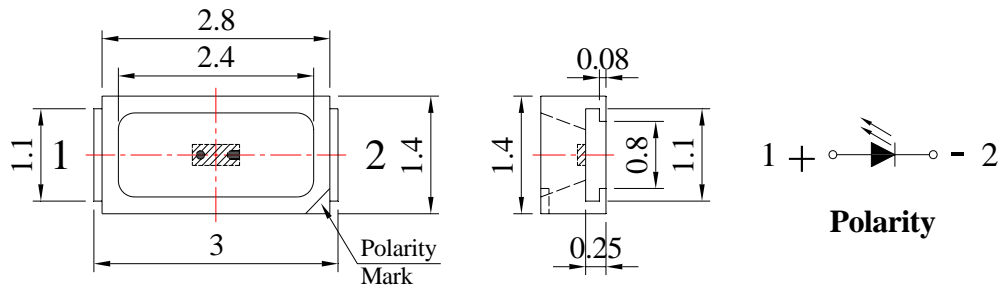

Recommended Soldering Pad Dimensions

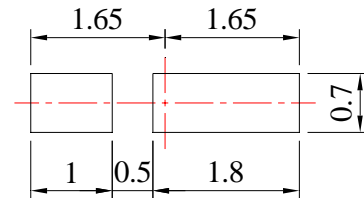

Unit: mm
Tolerance: $\pm 0.10\text{mm}$

Series No.	Chip Material		Lens Color	Emitting Color
R3014W-WXM-QXX	W2M-Q10	InGaN	Yellow Diffused	Cool White
	W5M-Q10	InGaN	Yellow Diffused	Neutral White
	W6M-Q10	InGaN	Yellow Diffused	Warm White

Notes:

1. All dimensions are in millimeters (inches).
2. Tolerance is $\pm 0.10\text{mm}$ (.004") unless otherwise specified.
3. Specifications are subject to change without notice.

Absolute Maximum Ratings at Ta=25°C

Parameters	Symbol	Max.	Unit
Power Dissipation	PD	118	mW
Peak Forward Current (1/10 Duty Cycle, 0.1ms Pulse Width)	IFP	50	mA
Continuous Forward Current	IF	30	mA
Reverse Voltage	VR	5	V
LED Junction Temperature	Tj	125	°C
Operating Temperature Range	Topr	-40°C to +80°C	
Storage Temperature Range	Tstg	-40°C to +85°C	
Soldering Temperature	Tsld	260°C for 5 Seconds	

Electrical Optical Characteristics at Ta=25°C

Parameters	Symbol	Emitting Color	Min.	Typ.	Max.	Unit	Test Condition
Luminous Intensity *	IV	W2M-Q10	3000	3800	---	mcd	IF=30mA
		W5M-Q10	3000	3600	---		
		W6M-Q10	3000	3600	---		
Luminous Flux *	Φv	W2M-Q10	10.0	12.5	---	lm	IF=30mA
		W5M-Q10	10.0	12.0	---		
		W6M-Q10	10.0	12.0	---		
Viewing Angle *	2θ1/2		---	120	---	Deg	IF=30mA
Chromaticity Coordinates	X	W2M-Q10	---	0.31	---		IF=30mA
		W5M-Q10	---	0.35	---		
		W6M-Q10	---	0.43	---		
	Y	W2M-Q10	---	0.32	---		
		W5M-Q10	---	0.36	---		
		W6M-Q10	---	0.40	---		
Color Temperature	CCT	W2M-Q10	5000	6500	---	K	IF=30mA
		W5M-Q10	3800	4500	5000		
		W6M-Q10	2600	3000	3800		
Color Rendering Index	CRI	W2M-Q10	---	75	---	Ra	IF=30mA
		W5M-Q10	---	75	---		
		W6M-Q10	---	75	---		
Forward Voltage	VF	W2M-Q10	2.80	3.40	3.80	V	IF=30mA
		W5M-Q10	2.80	3.40	3.80		
		W6M-Q10	2.80	3.40	3.80		
Reverse Current	IR	W2M-Q10	---	---	10	μA	VR=5V
		W5M-Q10	---	---	10		
		W6M-Q10	---	---	10		

Notes:

- Luminous Intensity Measurement allowance is ± 10%.
- θ1/2 is the off-axis angle at which the luminous intensity is half the axial luminous intensity.
- It use many parameters that correspond to the CIE 1931 2°. X, Y, and Z are CIE 1931 2° values of Red, Green and Blue content of the measurement.

Typical Electrical / Optical Characteristics Curves (25°C Ambient Temperature Unless Otherwise Noted)

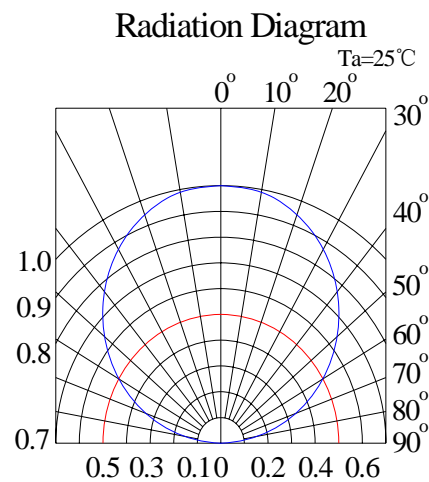
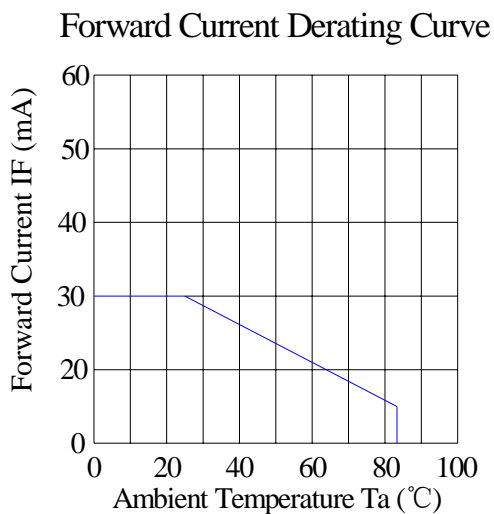
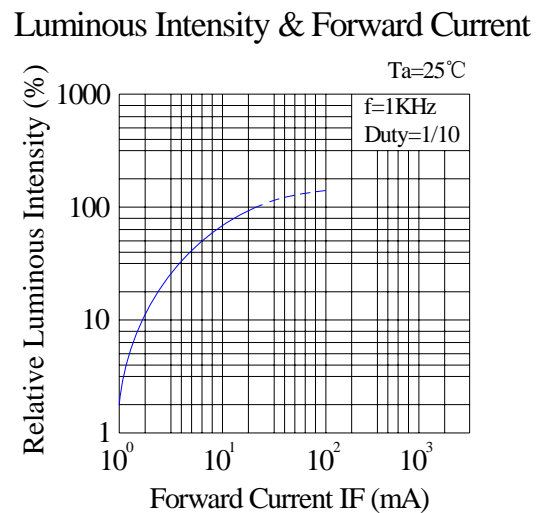
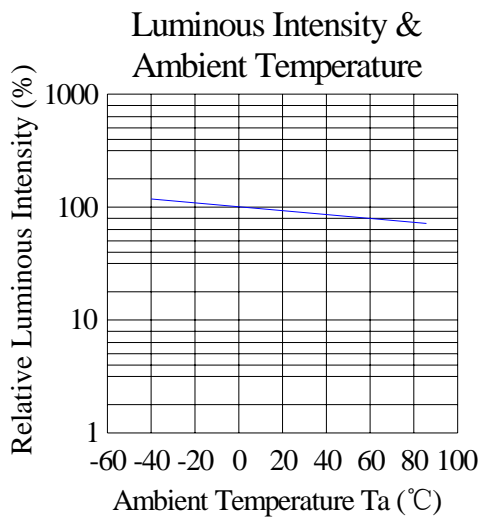
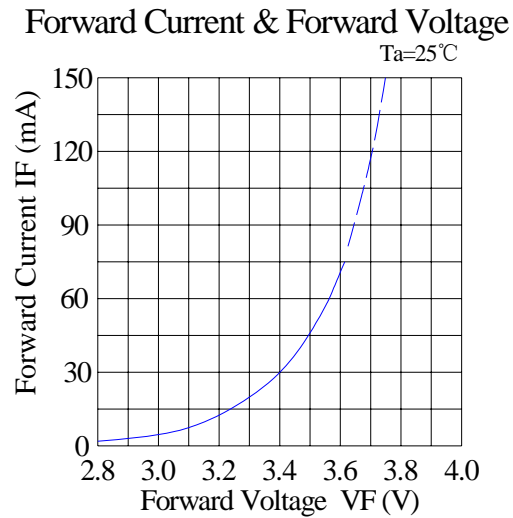
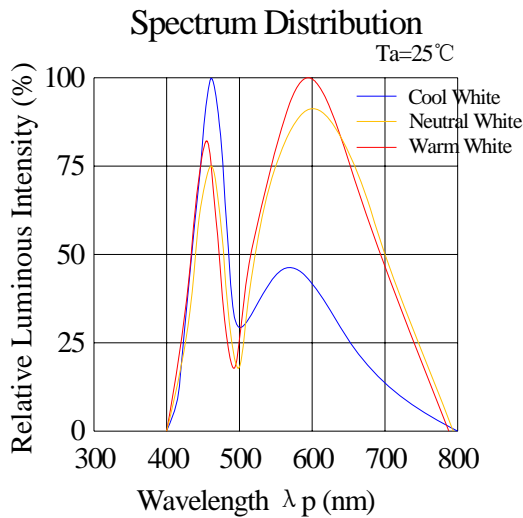

CIE Chromaticity Diagram:

Cool White:

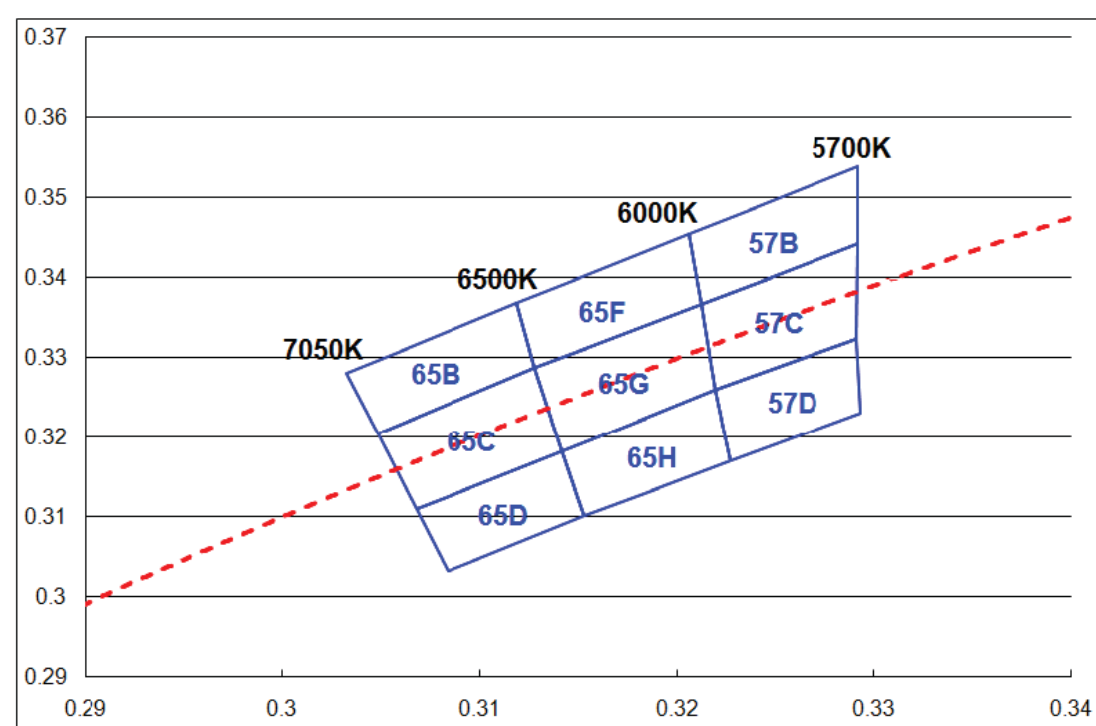

CIE Rank

Bin Code	CIE	Chromaticity Coordinate			
		X	Y	Z	W
65B	X	0.3032	0.3048	0.3128	0.3119
	Y	0.3280	0.3205	0.3288	0.3369
65C	X	0.3048	0.3068	0.3142	0.3128
	Y	0.3205	0.3110	0.3182	0.3288
65D	X	0.3068	0.3084	0.3153	0.3142
	Y	0.3110	0.3032	0.3100	0.3182
65F	X	0.3119	0.3128	0.3212	0.3206
	Y	0.3369	0.3288	0.3367	0.3454
65G	X	0.3128	0.3142	0.3219	0.3212
	Y	0.3288	0.3182	0.3260	0.3367
65H	X	0.3142	0.3153	0.3227	0.3219
	Y	0.3182	0.3100	0.3170	0.3260
57B	X	0.3206	0.3212	0.3292	0.3292
	Y	0.3454	0.3367	0.3443	0.3539
57C	X	0.3212	0.3219	0.3291	0.3292
	Y	0.3367	0.3260	0.3324	0.3443

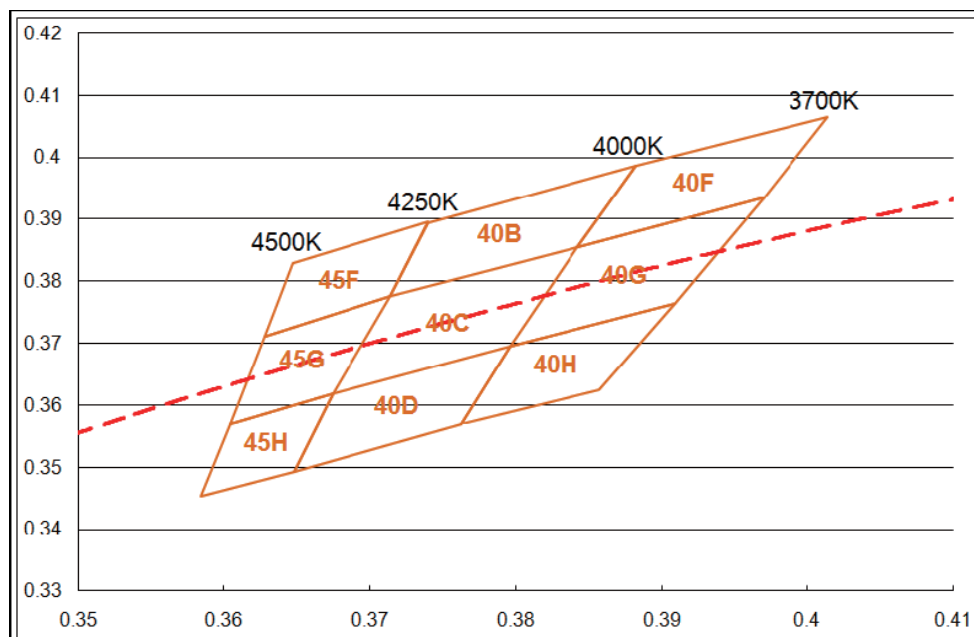
Neutral White:

CIE Rank

Bin Code	CIE	Chromaticity Coordinate			
45E	X	0.3667	0.3647	0.3740	0.3765
	Y	0.3944	0.3828	0.3895	0.4016
45F	X	0.3647	0.3628	0.3714	0.3740
	Y	0.3828	0.3711	0.3775	0.3895
45G	X	0.3628	0.3604	0.3675	0.3714
	Y	0.3711	0.3570	0.3619	0.3775
45H	X	0.3604	0.3584	0.3648	0.3675
	Y	0.3570	0.3454	0.3492	0.3619
40A	X	0.3765	0.3740	0.3882	0.3915
	Y	0.4015	0.3894	0.3987	0.4114
40B	X	0.3740	0.3714	0.3842	0.3882
	Y	0.3894	0.3775	0.3855	0.3987
40C	X	0.3714	0.3675	0.3796	0.3842
	Y	0.3775	0.3619	0.3696	0.3855
40D	X	0.3675	0.3648	0.3763	0.3796
	Y	0.3619	0.3492	0.3569	0.3696
40E	X	0.3915	0.3882	0.4014	0.4056
	Y	0.4114	0.3987	0.4065	0.4198
40F	X	0.3882	0.3842	0.3970	0.4014
	Y	0.3987	0.3855	0.3935	0.4065
40G	X	0.3842	0.3796	0.3909	0.3970
	Y	0.3855	0.3696	0.3764	0.3935
40H	X	0.3796	0.3763	0.3857	0.3909
	Y	0.3696	0.3569	0.3625	0.3764

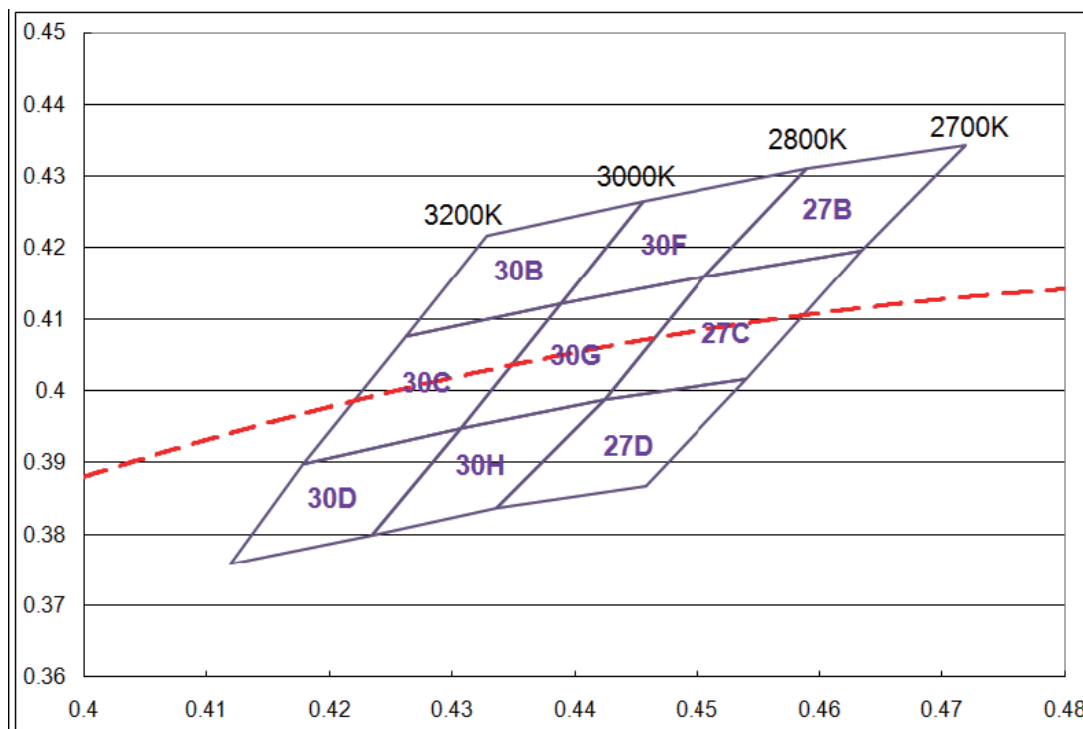
Warm White:



CIE Rank

Bin Code	CIE	Chromaticity Coordinate			
30B	X	0.4328	0.4263	0.4389	0.4456
	Y	0.4217	0.4076	0.4122	0.4265
30C	X	0.4263	0.4179	0.4307	0.4389
	Y	0.4076	0.3898	0.3948	0.4122
30D	X	0.4179	0.4120	0.4235	0.4307
	Y	0.3898	0.3758	0.3799	0.3948
30F	X	0.4456	0.4389	0.4506	0.4590
	Y	0.4265	0.4122	0.4159	0.4311
30G	X	0.4389	0.4307	0.4424	0.4506
	Y	0.4122	0.3948	0.3987	0.4159
30H	X	0.4307	0.4235	0.4336	0.4424
	Y	0.3948	0.3799	0.3836	0.3987
27B	X	0.4590	0.4506	0.4634	0.4719
	Y	0.4311	0.4159	0.4197	0.4344
27C	X	0.4506	0.4424	0.4541	0.4634
	Y	0.4159	0.3987	0.4016	0.4197
27D	X	0.4424	0.4336	0.4458	0.4541
	Y	0.3987	0.3836	0.3868	0.4016

Notes:

1. Color coordinates measurement allowance is ± 0.01 .
2. One delivery will include up to two consecutive color ranks and three luminous intensity ranks of the products the quantity-ratio of the ranks is decided by **LuckyLight**.

Reliability Test Items And Conditions:

The reliability of products shall be satisfied with items listed below:

Confidence level: 90%.

LTPD: 10%.

1) Test Items and Results:

No.	Test Item	Test Hours/Cycles	Test Conditions	Sample Size	Ac/Re
1	Resistance to Soldering Heat	6 Min	Tsld=260 \pm 5 $^{\circ}$ C, Min. 5sec	25pcs	0/1
2	Thermal Shock	300 Cycles	H: +100 $^{\circ}$ C 5min \int 10 sec L: -10 $^{\circ}$ C 5min	25pcs	0/1
3	Temperature Cycle	300 Cycles	H: +100 $^{\circ}$ C 15min \int 5min L: -40 $^{\circ}$ C 15min	25pcs	0/1
4	High Temperature Storage	1000Hrs.	Temp: 100 $^{\circ}$ C	25pcs	0/1
5	DC Operating Life	1000Hrs.	IF=30mA	25pcs	0/1
6	Low Temperature Storage	1000Hrs.	Temp: -40 $^{\circ}$ C	25pcs	0/1
7	High Temperature/High Humidity	1000Hrs.	85 $^{\circ}$ C/85%RH	25pcs	0/1

2) Criteria for Judging the Damage:

Item	Symbol	Test Conditions	Criteria for Judgment	
			Min	Max
Forward Voltage	VF	IF=30mA	---	F.V.*) \times 1.1
Reverse Current	IR	VR=5V	---	F.V.*) \times 2.0
Luminous Intensity	IV	IF=30mA	F.V.*) \times 0.7	---

*) F.V.: First Value.

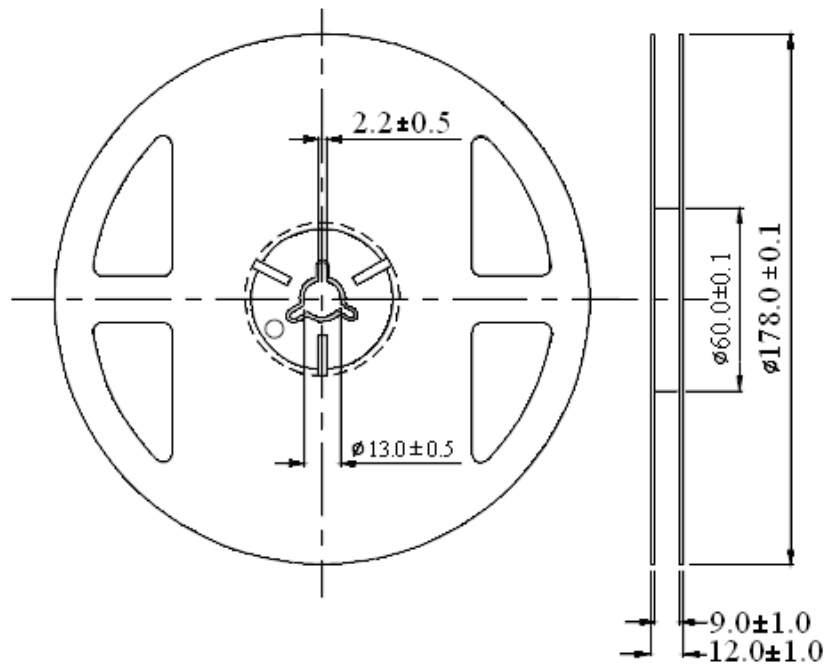
Reel Dimensions:

Unit: mm
Tolerance: ± 0.25 mm

Carrier Tape Dimensions:

Loaded quantity 3000PCS per reel.

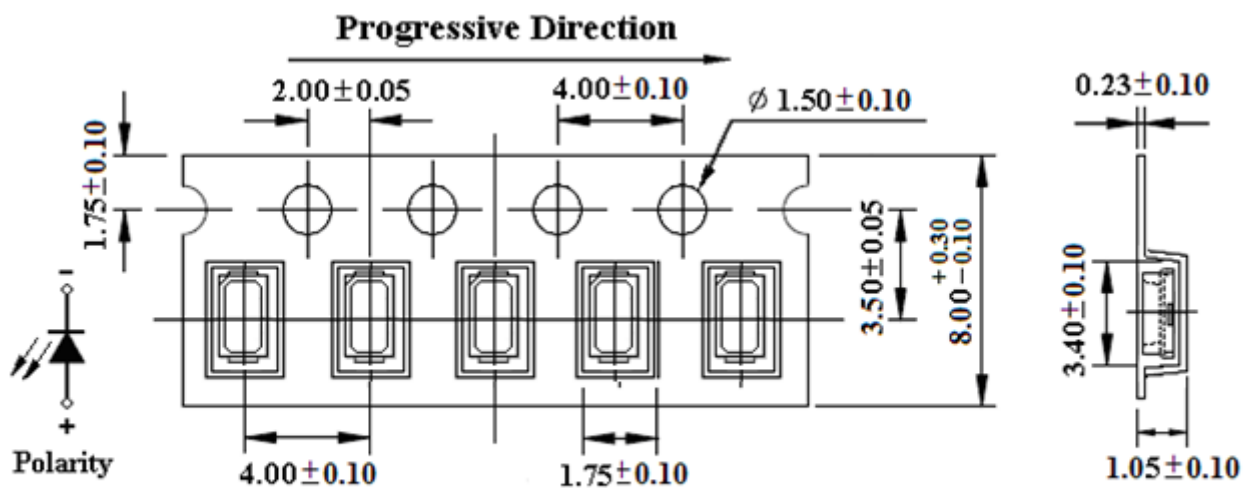

Unit: mm
Tolerance: ± 0.10 mm

Please read the following notes before using the product:

1. Over-current-proof

Customer must apply resistors for protection, otherwise slight voltage shift will cause big current change (Burn out will happen).

2. Storage

- 2.1 Do not open moisture proof bag before the products are ready to use.
- 2.2 Before opening the package, the LEDs should be kept at 30°C or less and 80%RH or less.
- 2.3 The LEDs should be used within a year.
- 2.4 After opening the package, the LEDs should be kept at 30°C or less and 60%RH or less.
- 2.5 The LEDs should be used within 168 hours (7 days) after opening the package.
- 2.6 If the moisture adsorbent material has fabled away or the LEDs have exceeded the storage time, baking treatment should be performed using the following conditions. Baking treatment: 60±5°C for 24 hours.

3. Soldering Condition

When soldering, for Lamp without stopper type and must be leave a minimum of 3mm clearance from the base of the lens to the soldering point.

To avoided the Epoxy climb up on lead frame and was impact to non-soldering problem, dipping the lens into the solder must be avoided.

Do not apply any external stress to the lead frame during soldering while the LED is at high temperature.

Recommended soldering conditions:

Soldering Iron		Wave Soldering	
Temperature	300°C Max.	Pre-heat	100°C Max.
Soldering Time	3 sec. Max. (one time only)	Pre-heat Time	60 sec. Max.
		Solder Wave	260°C Max.
		Soldering Time	5 sec. Max.

Note: Excessive soldering temperature and / or time might result in deformation of the LED lens or catastrophic failure of the LED.

4. Soldering Iron

Each terminal is to go to the tip of soldering iron temperature less than 260°C for 5 seconds within once in less than the soldering iron capacity 25W. Leave two seconds and more intervals, and do soldering of each terminal. Be careful because the damage of the product is often started at the time of the hand solder.

5. Repairing

Repair should not be done after the LEDs have been soldered. When repairing is unavoidable, a double-head soldering iron should be used (as below figure). It should be confirmed beforehand whether the characteristics of the LEDs will or will not be damaged by repairing.

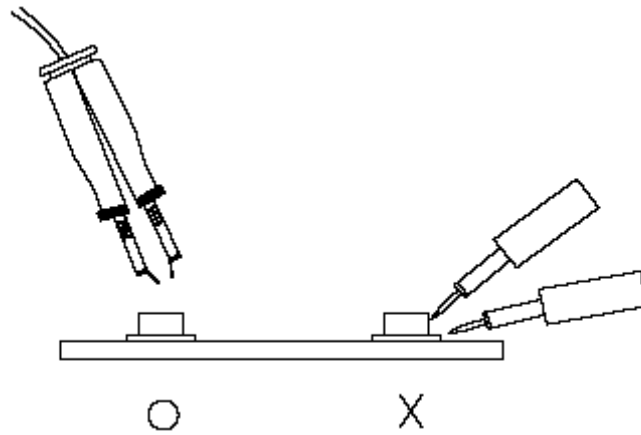

6. Caution in ESD

Static Electricity and surge damages the LED. It is recommended to use a wrist band or anti-electrostatic glove when handling the LED. All devices, equipment and machinery must be properly grounded.